

SANITATION

FOR YOU & ME

(A Post-Tsunami
Technical Overview)

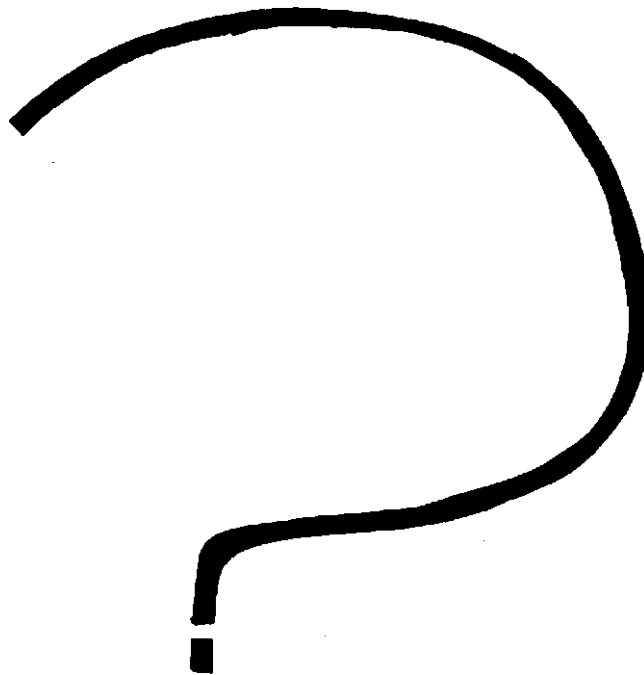

3/1

Foreword

The tsunami of December 2004 will remain in the memories of the affected people, as a black day. The effects of the unprecedented havoc will take a long time to be erased from people's memories.

The thousands of people who came forward to contribute and support in the reconstruction initiative is heart warming. Many initiatives, innovations were brought about during this time and all these have to be appreciated and congratulated. However, even as we take pride in how far we have come, we should acknowledge that these are just the first steps of a much longer journey.

Sanitation is major issue in our country, and India has been promoting the Total Sanitation programme enthusiastically. It is also a very difficult topic to address due to the stigma attached and the social barriers that exist.

This book goes a long way in making the topic simple and understandable and shows us new directions that need to be taken in future. It has taken an important step towards informing the public, practitioners, professionals the various issues and solutions in Sanitation.

It captures the spirit of this emerging and alarming issue and highlights the pitfalls that need to be avoided. It ensures that the all people from the activist to the technician can understand and argue for a better solution.

The payoffs to users of this book will be in the significant insights that enable them to solve vital problems at the frontiers of their fields and at the local level.

I appreciate the effort made by the production team and Alok Patnaik to bring out this publication. I encourage all readers and users of the guide to take the message forward.

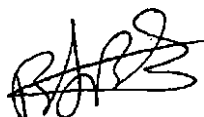

Benjamin Larroquette
UN Tsunami Recovery Manager

SANITATION

FOR YOU & ME

(A Post-Tsunami
Technical Overview)

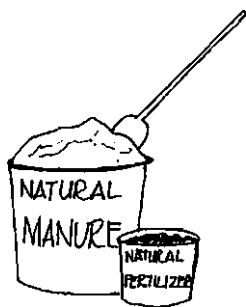
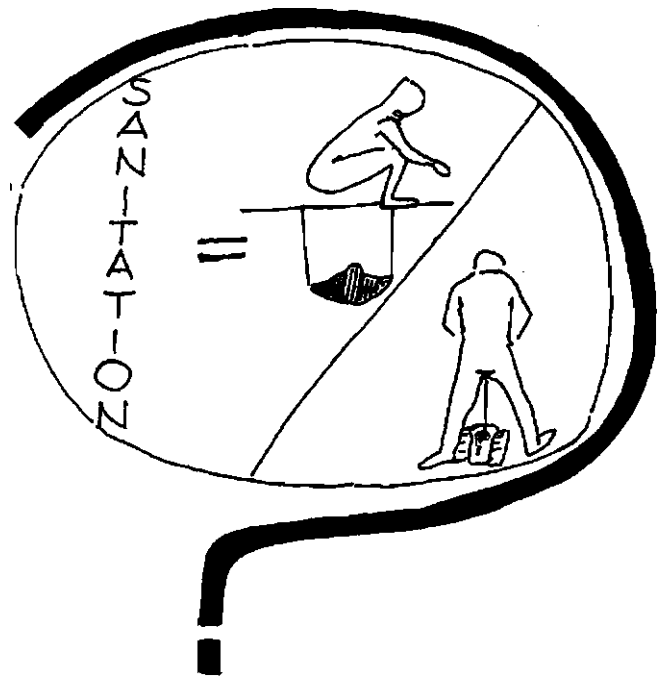

Table of Contents

Preface	3
I Issues on Sanitation	
Health Aspects	9
What is Sanitation?	11
Sanitation in India	13
Prioritising Sanitation	17
II Waste	
Understanding Waste	21
Faeces to Fertiliser?	23
Using Urine	27
Other Wastes	31
Composting	33
III Types of sanitation Units	
Simple Pit Latrines	37
Overhung Latrines	39
Ventilated Improved Pit Latrines	41
Pour Flush Toilets	45
ECOSAN (Ecological Sanitation)	47
DEWATS (Decentralised Waste Water Treatment System)	55
FBRR (Finalised Biological Bed Reactor)	63
SPISF (Single Pass Intermittent Sand Filter)	65
IV Technical Details	
Construction of Pits	69
Construction of Floor Slabs, Moulds	71
Vent Pipe & Fly Screen	73
School Toilets Design	75
Low Cost Incinerator	79
V Appendixes	
Training and Educational Materials	81
Information Resources & Reference	85
Contacts & Resources Persons	89
Glossary	93

PREFACE

We are very fortunate that there was no major disease outbreak after the December 2004 tsunami which devastated coastal villages in the 13 districts of Tamil Nadu.

Nonetheless, it would be prudent to keep emphasising the need for good sanitation in the post Tsunami Reconstruction work. Over the past three years, several interesting and significant programmes and events related to sanitation have taken place -- Children's sanitation parliament, 250 ECOSAN toilets in a single village, SHG members taking charge of a pay-and-use DEWATS toilet complex, A toilet beauty contest etc.

However, even as several NGOs wind up their WATSAN (Water and Sanitation) projects, many settlements remain uncovered and basic sanitary and drinking water facilities are not available. A few scattered attempts are still on. Perhaps the push given by Tsunami related projects, need to be carried forward through regular development efforts, not only by NGOs, but also by opinion leaders, local bodies and CBOs (Community-based Organisations).

In order to take this effort forward, the location of information, knowledge, and technical information needs to shift to the local level. While there is always the need to provide basic technical information on the kind of toilets, or latrines that individual people can have, there needs to be a wider awareness of the linkages between sanitation & community health. Along with this, there is need to move towards a more "ecological view" of human and other waste.

A good basic toilet serves the purpose of defecating in privacy and helps in maintenance of cleanliness and personal hygiene. Beyond that there is the question of disposal of the excreta. This calls for processing of our waste. The question however is what kind of resources is society willing to use up for this. All things considered, we would certainly prefer an eco-friendly toilets which can provide compost and fertilizer, while saving thousands of litres of water and all this without causing any harm to our surroundings!

There may be many factors which influence the choice of toilet and many of them maybe beyond ones control. The tragedy however is that most of us don't choose the type of toilet that we build. The choice is made by someone else or by circumstances. And most of the time, we don't even know that these options exist. We are just told by the leaders or the 'experts', that this has to be done.



This manual aims to do something about this. We believe that sanitation is not rocket science, and all of us need to understand more about it, and the choices before us, so that we can ask the leaders, and the experts, the right questions, and make the right choices.

Thus the emphasis of this manual is not only to give you the basic technical information, but also to demystify some of these concepts which are often made to look like complicated systems and codes, which only a few can crack.

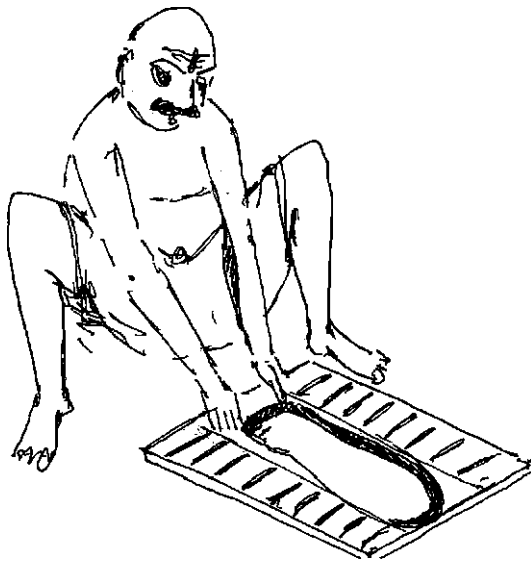

We hope to promote awareness about the technical issues among the local community members who could apply some of these along with their traditional wisdom to their own local environment. The idea is to kick-start by taking small steps based on an informed choice and applying simple logic behind each small step, which would ensure a strong foundation not just for your toilet or a disposal system but for a healthy, safe and secure life ahead. It is put together more as a bridge between the purely technical reader,

and the local level leader or activist. It is aimed at providing the latter with the essential skills and knowledge to motivate and educate local people on one hand and provide competent feedback and instructions to the technician on the other. More importantly it seeks to educate enough to empower the local person to take decisions, which have hitherto been the preserve of the expert.

In this manual we will look at the broader issues of sanitation, handling of waste (Section II), and then examines the sanitation option that we have (Section III), and then give some other technical details on construction & design (Section IV). The pure technical stuff is clearly marked, and we hope that this would be useful for masons, leaders and activists alike. As an information centre, we also thought it necessary to provide references and more information of resources (Appendix). These references are not meant to be academic citations. They are meant for those who want to know more. Each and every one of these references are available at CED library, which you can access at any time. We have provided the CED access codes against each and every reference (in square brackets) for your convenience. Most of the text is also available at our website. We also have web version of this manual at <http://www.doccentre.net/docsweb/san-tech-man.html>.

Finally, this is a continuous effort and we will keep updating this manual. That is why this manual is organised more as a file, with different sections, each having separate page numbering. We hope to make additions and developments in each section. Further, we invite you to add notes and pages of your own. If you send these to us, we will definitely share this with others, and put it on the website.

Finally, as we have said elsewhere in this manual, we do not claim any original or new ideas. We have rather relied on people from the field, and on earlier writings. Some of them are:

A Guide to Sanitation and Hygiene for those Working in Developing Countries by *Sari Huuhtanen and Ari Laukannen*. Global dry toilet club of Finland, Tampere polytechnic, University of Applied Sciences. http://www.drytoilet.org/pdf/Sanitation_Guide.pdf
[C.eldoc1/d70d/sanitaion-hygiene-dev-countries.pdf]

DEWATS : Decentralised Wastewater Treatment in Developing Countries by *Ludwig Sasse*

<http://documents.scribd.com/docs/1ptpt0a12zsowos99331.pdf>
[C.eldoc1/d70d/undp1_980101zzz1B.pdf]

Decentralized Wastewater Treatment Systems Dissemination Project Indonesia, BORDA, BEST, Kerja Sama (Republic of Indonesia).

[C.eldoc1/d70d/undp1_080228zzz1B.pdf]

Toilets that make Compost- Low-cost, sanitary toilets that produce valuable compost for crops in an African context By *Peter Morgan*, Stockholm Environment Institute EcoSanRes Programme 2007.

http://www.ecosanres.org/pdf_files/ToiletsThatMakeCompost_lowres_greyscale.pdf
[C.eldoc1/d70d/undp1_070101zzz1B.pdf]

How to Construct a Brick VIP Latrine, A step by step manual for training Public Health Technicians A joint publication by African Medical and Research Foundation and Kenya Water for Health Organisation Edited by Nicholas Greenacre, illustrated by Juliet Waterkeyn.
[C.eldoc1/d70d/how-to-construct-VIP-latrine.pdf]

We have also been guided and supported by Vijay Anand of Exnora International, Chennai who took a great interest in this work and provided us with his valuable inputs. We would also like to thank M Subburaman of Society for Community Organisation and People's Education (SCOPE) Trichy, Joe D'Souza, Consortium for DEWATS Dissemination (CDD) Society Bangalore and particularly V Ganapathi [advisor for Exnora Borda Eco-sanitation project].



CED Team
May 2008



Issues on Sanitation

Toilets, urine, faeces!

What an unpleasant thing to talk about! That's how most of us react to the very word. Further there are many taboos associated with defecation, most of which are actually principles of hygiene/cleanliness associated with traditional practices of sanitation, and living systems

Open defecation has been the most common sanitation practice for several hundred years and it still continues to be so. Back then however it was acceptable as all the shit would just dry under the sun and decompose in the mud without posing any health hazard. Today, open defecation in India would mean that every day, 2,00,000 metric tonnes of faeces would find its way into water bodies, thus posing a potential threat to the very source of life. There is too much shit around to be taken care of by nature itself. It is our responsibility.

So what's the solution?

Toilets. Perhaps. However many studies in the developing countries show that latrines alone do not eliminate sanitation related diseases. Some times it aggravates it. The trick lies in what we do with all that waste that we generate.

So what do we do with so much waste that we generate?

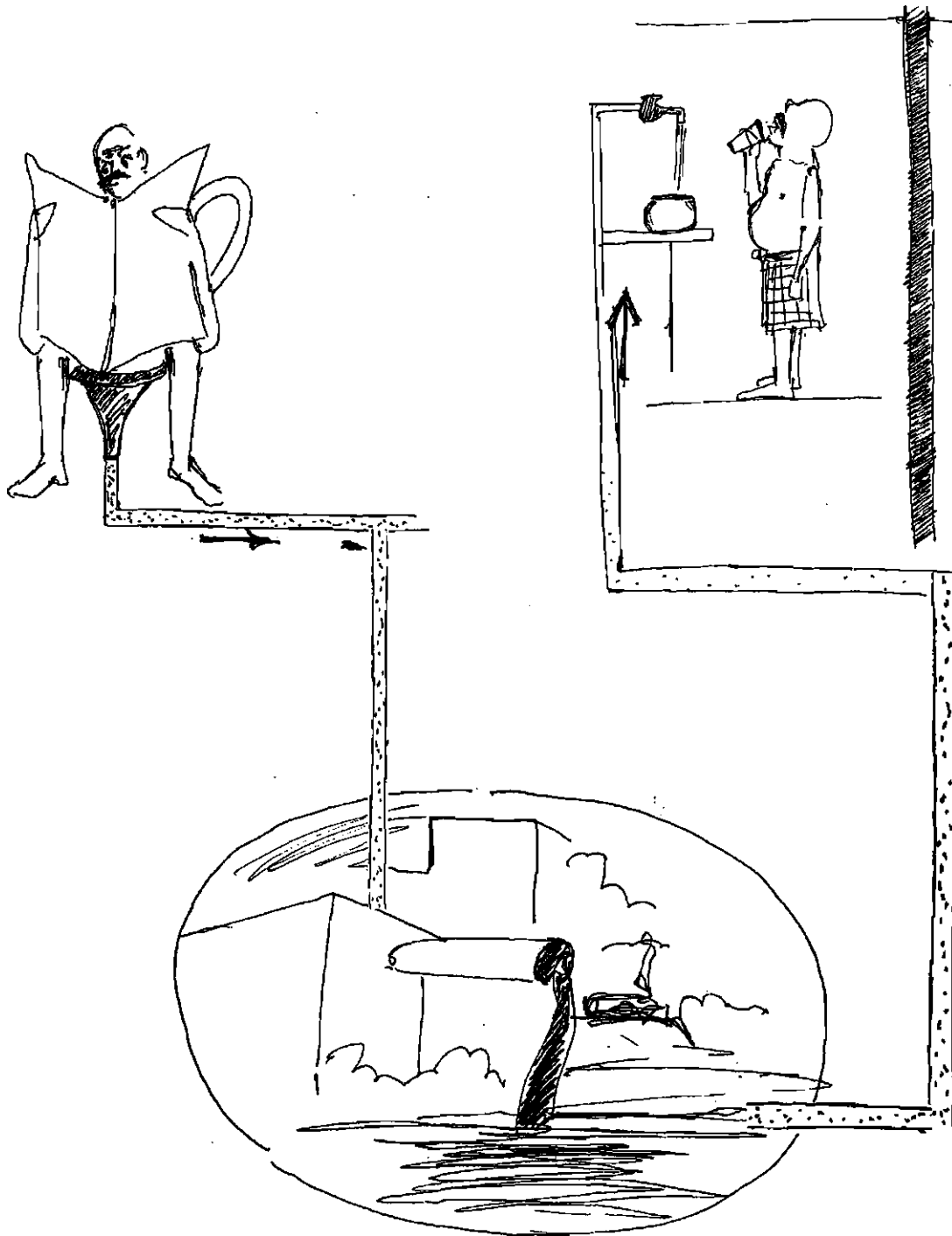

Untreated Waste leads to water contamination

HEALTH ASPECTS

One gram of faeces could contain 10 million viruses, 1 million bacteria, a thousand parasite cysts and a hundred worm eggs. And every minute, 1.1 million litres of raw sewage is dumped into the Ganges river alone. And this is just the tip of the iceberg! In fact every day 2, 00,000 metric tonnes is added to the surface of the earth in open defecation. This waste finds its way into the soil and into water bodies. Thus infecting our very source of life.

A Diarrhoea of Death!

Over 2 million people die annually due to diarrhoea, wherefrom most are under the age of five. Every day approximately 6000 children die to diarrhoea related diseases.

Poor sanitation is directly responsible for the high incidence of diarrhoeal disease.

3 billion people lack safe sanitation

2.4 billion people have no access to basic sanitation

5.7% of diseases are due to poor sanitation and hygiene

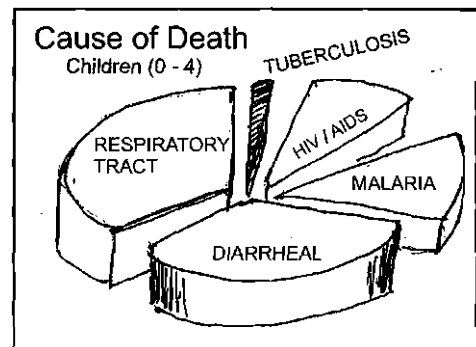

Nearly 4 children die every minute from unsafe water and inadequate sanitation.

"In India there are 700 million people who do not have access to safe and hygienic toilets. The waterborne diseases this causes, kill 500,000 children every year, mostly from diarrhea," said Bindeshwar Pathak, the head of the Sulabh Sanitation and Social Reform Movement.

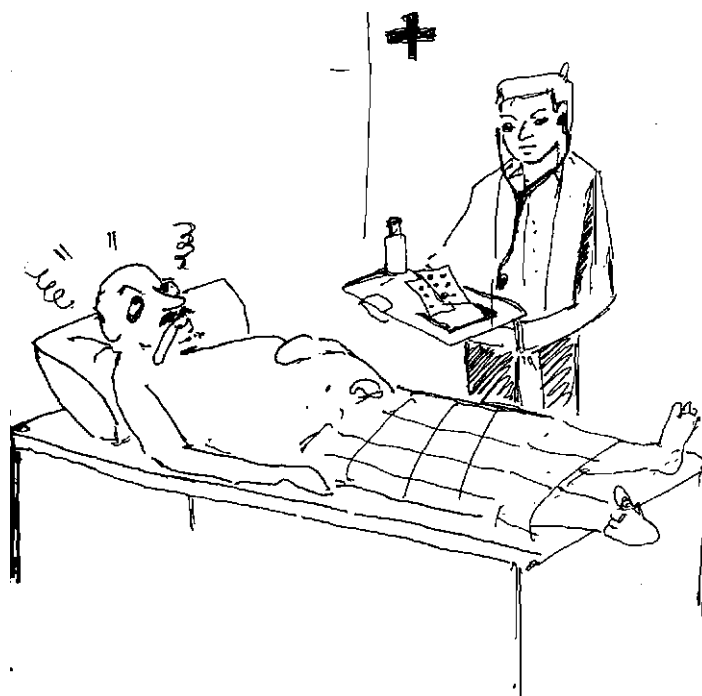

Excreta mixed with water contaminates the groundwater. This water is used by us for cooking, drinking, bathing and washing clothes. Polluted water and inadequate sanitation cause 5-7% percent of all epidemics especially among children.

Several diseases like diarrhoea, cholera, typhoid fever, hepatitis-A, dysentery and guinea-worm disease spread in the absence of proper sanitation and adequate treatment or disposal of human excreta. The excreta when left on the surface attracts flies and insects responsible for spreading diseases by contaminating our food and water.

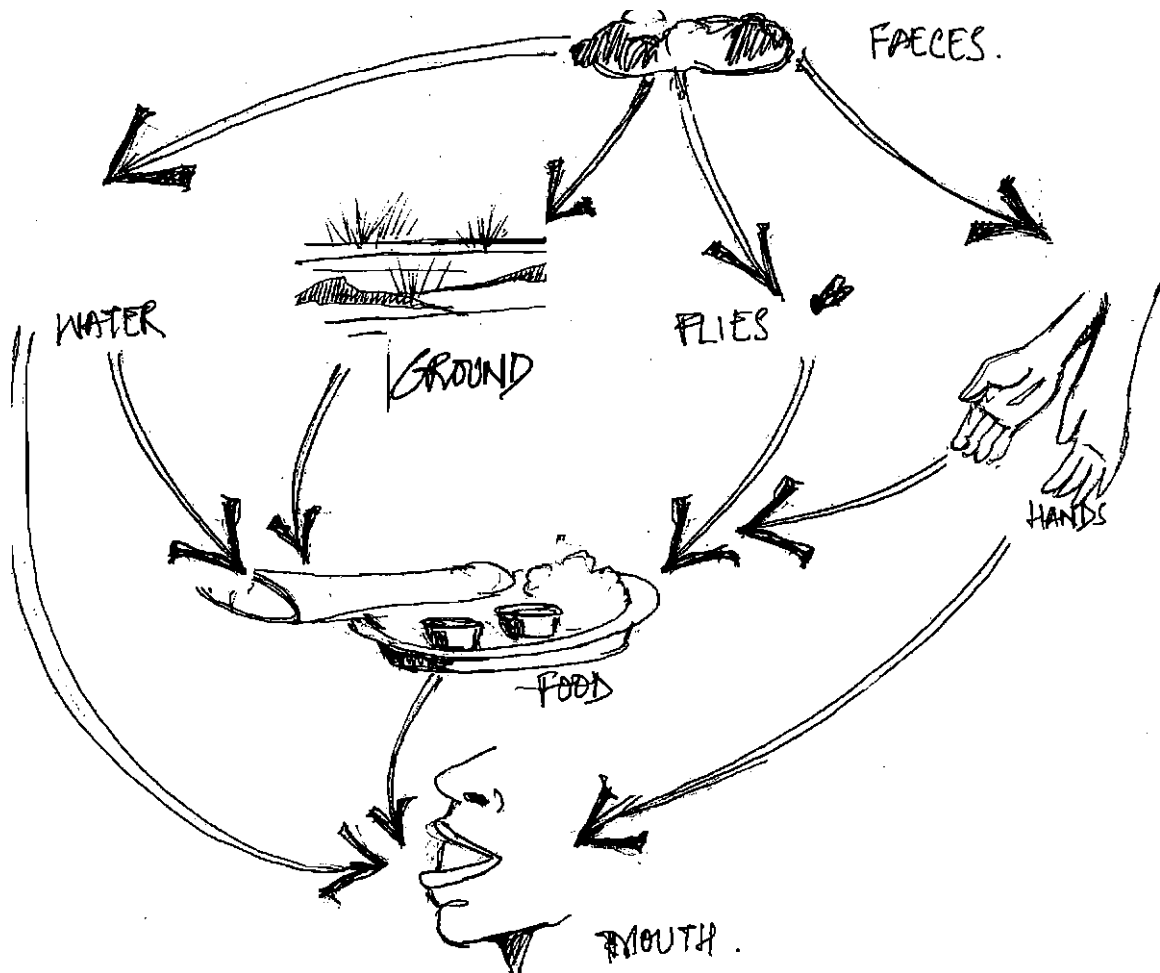

A cycle of disease from faeces to mouth

Further reading

Quick Scan Health Benefits And Costs Of Water Supply And Sanitation by J.J. Bos, & others.

http://www.gpa.unep.org/documents/quick_scan_health_benefits_english.pdf [C.eldoc1/d70d/quick_scan_health_benefits_english.pdf]

A guide to sanitation and hygiene for those working in developing countries by Sari Huuhtanen and Ari Laukannen, Global dry toilet club of Finland, Tampere polytechnic, University of Applied Sciences.

http://www.drytoilet.org/pdf/Sanitation_Guide.pdf
[C.eldoc1/sanitation/hygeine-sanitation-relatedness.pdf]

WHAT IS SANITATION?

Whatever ones definition of sanitation, surely, for it to be considered "sanitary", it must be ensured that it does not cause disease or even discomfort for all, and the environment. This means that the sanitary system must effectively block the spread of pathogens, by creating barriers between the pathogen and food and the body. As shown in this diagram, the barriers are created by personal hygiene, food hygiene, water disinfection, and

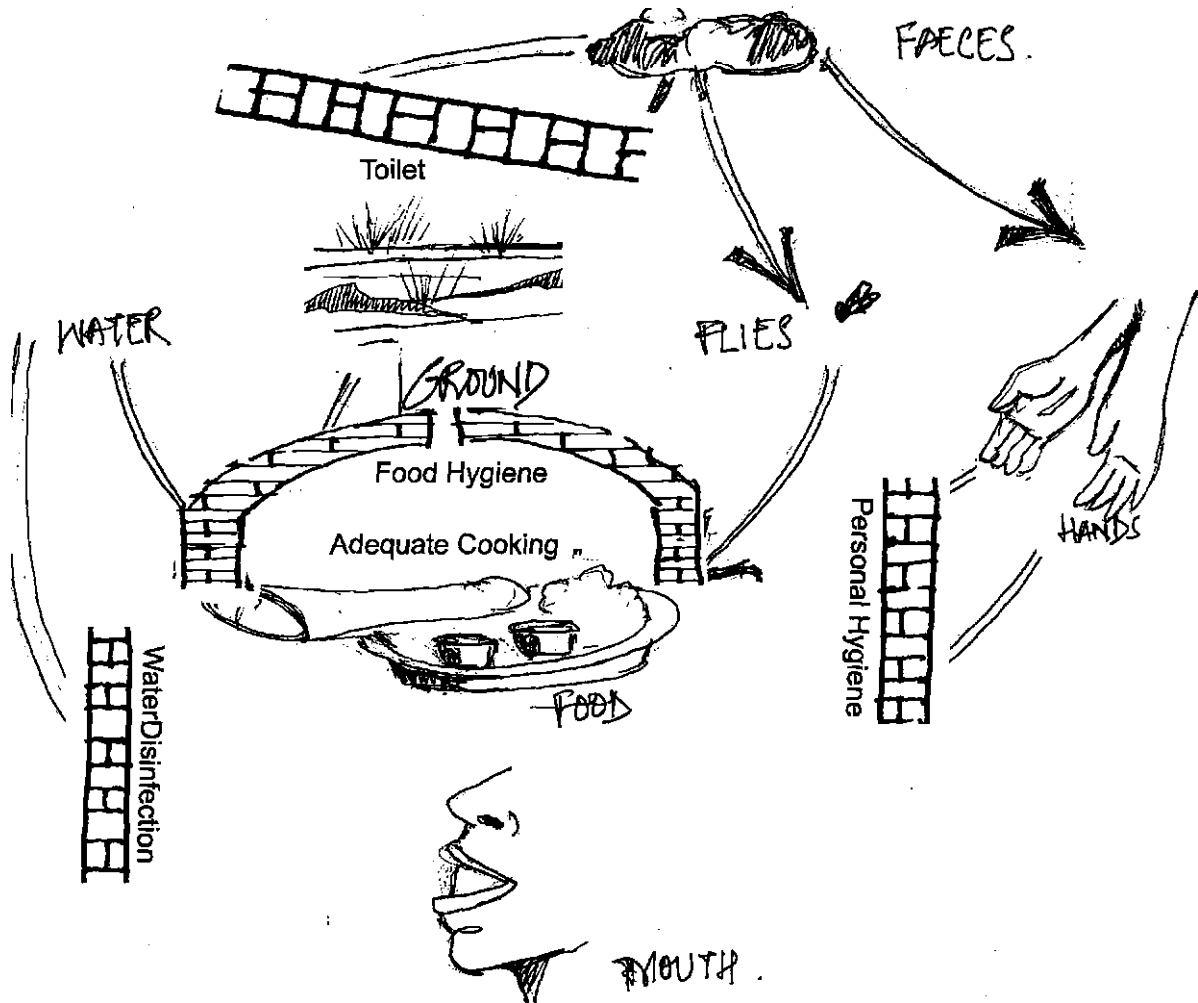

Toilets, personal hygiene, water disinfection and food hygiene break the disease causing cycle

adequate cooking. While these barriers represent what you can do at the personal level, they become inadequate, when we do not have the important barrier of toilets and safe disposal of waste at the community level.

Thus Sanitation means more than toilets. It includes collecting and disposing human excreta and urine, as well as other waste water, in a manner that is "sanitary" (safe and healthy).

Thus "sanitation" covers all aspects of environment and household cleanliness as well as personal hygiene- human excreta and waste water disposal, garbage and cattle dung disposal, use of smokeless *chulbas*, clean houses and food.

UN's world summit on sustainable development, 2002 outlined the following activities and programmes as essentials towards good sanitation.

Setting up...

- Efficient household sanitation systems
- Sanitation in public institutions, especially in schools

Using...

- Affordable and also socially and culturally acceptable technologies
- Integration of sanitation into water resources management
- Innovative financing and partnership mechanisms
- Environment friendly alternatives

Promotion of...

- Safe hygiene practices
- Education and outreach focused on children, as agents of behavioral change

The Millennium Development Goal 7 which deals with ensuring environmental sustainability, emphasised the need to halve proportion of people suffering from lack of access to safe drinking water and basic sanitation by 2017. In the same goal, it spoke of integrating sustainable development principles into country programmes to reverse the loss of environmental resources.

Further reading:

The vast deficit in sanitation. Chapter 3 in Human Development Report 2006. UNDP-
http://hdr.undp.org/hdr2006/pdfs/report/HDR_2006_Chapter_3.pdf. [C:Eldoc1/D70d/ HDR_2006_Chapter_3.pdf]

A Guide to the Development of on-Site Sanitation.
R Franceys, J Pickford & R Reed. WHO, 1992.
http://www.who.int/water_sanitation_health/hygiene/envsan/onsitesan.pdf
[C:eldoc1/sanitation/guide-onsite-sanitation.pdf]

www.ecosanres.org

SANITATION IN INDIA

In order to meet the MDG 7, roughly an additional 117 million rural population would have to be connected to piped water or given access to mini water supply schemes, and an additional 106 million people should have access to household toilets. This means investment programmes of about Rs 353 billion for water supply and Rs 53 billion for sanitation in the 11th Plan; and Rs 307 billion for water supply and Rs 53 billion for sanitation in the 12th Plan.

Rural Sanitation in India

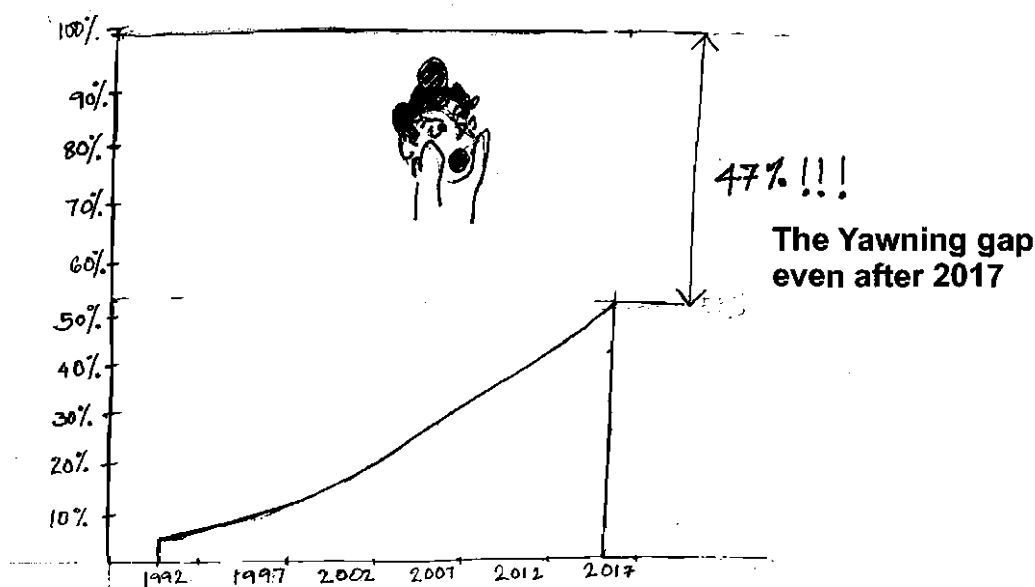

	1992	1997	2002	2007	2012	2017
☐ Rural Population served	6%	10%	20%	32%	43%	53%
☐ Access to flush toilets	0.60%	2%	9%	9%	8%	8%
☐ Access to pit latrines	5%	7%	11%	24%	35%	45%

Source: www.worldbank.org based on linear estimates on Census Data, CSO & Plan documents (Ref no..)

The Government of India however is planning to up its investment, and is targeting 100% sanitation infrastructure coverage by 2012.

Total Sanitation Programme

Total Sanitation Programme (TSC) a part of the reform programme was initiated in 1999 to ensure sanitation facilities in rural areas, with the broader goal to eradicate the practice of open defecation.

The Total Sanitation Programme (TSC) is being implemented with the district as unit on a project mode. A proposal needs to be sent from the district, and once approved; the campaign is implemented in phases.

The start-up activities, for which central funds are made available, are for Information Education & Communication (IEC). These are location specific and intensive. They should involve Panchayati Raj Institutions, Co-operatives, Women Groups, Self Help Groups, and NGOs etc. The IEC strategy should be such that it addresses all sections of rural population to bring about the relevant behavioural changes for improved sanitation and hygiene practices.

As far as the sanitation programme itself is concerned, the TSC does not provide for a general subsidy for each latrine built. For the BPL (Below Poverty Line) Families there are incentives in the form of part subsidy to the tune of Rs 1,200 to construct a toilet. Subsidy is also given for constructing toilets in common areas like schools, *anganwadis* and women's sanitary complexes.

For the middle level families, TSC aims to provide a choice of hardware and technologies. Under this scheme, you can hope to build alternative delivery channels namely the Rural Sanitary Marts and Production Centres which could be opened and operated by NGOs/ SHGs/ Women Organisations/Panchayats. Other essential components of the TSC are the Community Sanitary Complex and School Sanitation & Hygiene Education.

Many have suggested Community Sanitation as the answer to the economic problem. In fact in some urban areas, people have welcomed these community toilets or *Shauchalayas*, even when they have had to pay a fee for usage. This has meant that NGOs, and more recently and significantly local peoples' organisations have been able to maintain these community facilities.

However some experts who have been closely observing the post-tsunami sanitation scenario believe that there is a need for providing individual toilets. Also in rural areas the privacy and safety issue for women and young girls means that toilet facilities will have to be more convenient than what community toilets can offer.

Under the TSC programme, each of the districts would be entitled subsidies for BPL families as well as Community Sanitary Complexes, Rural Production Centres, and Sanitary Marts. These programmes in conjunction with money available for Post Tsunami reconstruction, could provide a good vertically integrated solution.

In early 2007, the Tamil Nadu government decided to provide wastewater treatment systems like FBBR, SPISF and DEWATS only for urban areas i.e. areas that fall under Municipal and Town Panchayat limits. This therefore covers 73 out of the total of 205 settlements. It was suggested that it's better to go for soak pits in the rural settlements

Probably the basic flaw in the whole demand driven approach of the TSC is that it presumes that an IEC programme alone is sufficient to create the demand for sanitation. If we have to achieve the millennium development goal of at least 50% of the Indian population having toilets by 2015, this roughly translated to construction of 6000-7000 toilets per second.

Further readings:

Learning from Experience.-Water and Environment Sanitation in India, UNICEF, New York.

http://www.unicef.org/publications/files/pub_wes_en.pdf
[C.eldoc1/d70d/Water-environment-sanitation.pdf]

Guidelines. Central Rural Sanitation Programme. Total Sanitation Campaign December 2007, Ministry of Rural Development.

<http://ddws.gov.in/popups/TSC%20Guideline%20Oct07.pdf>
[C.eldoc1/d70d/undp1_071201zzz1B.pdf]

Rural upliftment through total sanitation by Nitya Jacob, GRASSROOTS,

http://www.pressinstitute.org/scripts/grassroots_english.asp.
[C.eldoc1/d70d/TSC-rural-upliftment.pdf]

PRIORITISING SANITATION

A majority of our people are living far below the minimum standards. There are many excuses. Some say that while defecating on the sea shore: a fisherman observes the wave-patterns. Perhaps. But if he does not have a toilet, he will spend about fifteen minutes to walk upto the spot and back. Wouldn't it be easier for a fisherman to shit at home for three minutes, and just walk out to the beach close-by, and observe the wave-pattern for more than ten minutes?

Or that when he is at sea, he prefers doing it over-board. True when he is away for over twelve hours. But otherwise, wouldn't he feel better to relieve himself at home, before setting out to work?

Among the factors that influence sanitation decisions, the most important factor is of course the economic factor. Those living below the poverty line, and those who barely have any surplus after taking care of the food needs, definitely cannot afford to spend any money or resources building toilets.

Needs and Demand

The truth is that at the individual level, people have different levels of needs for sanitation viz

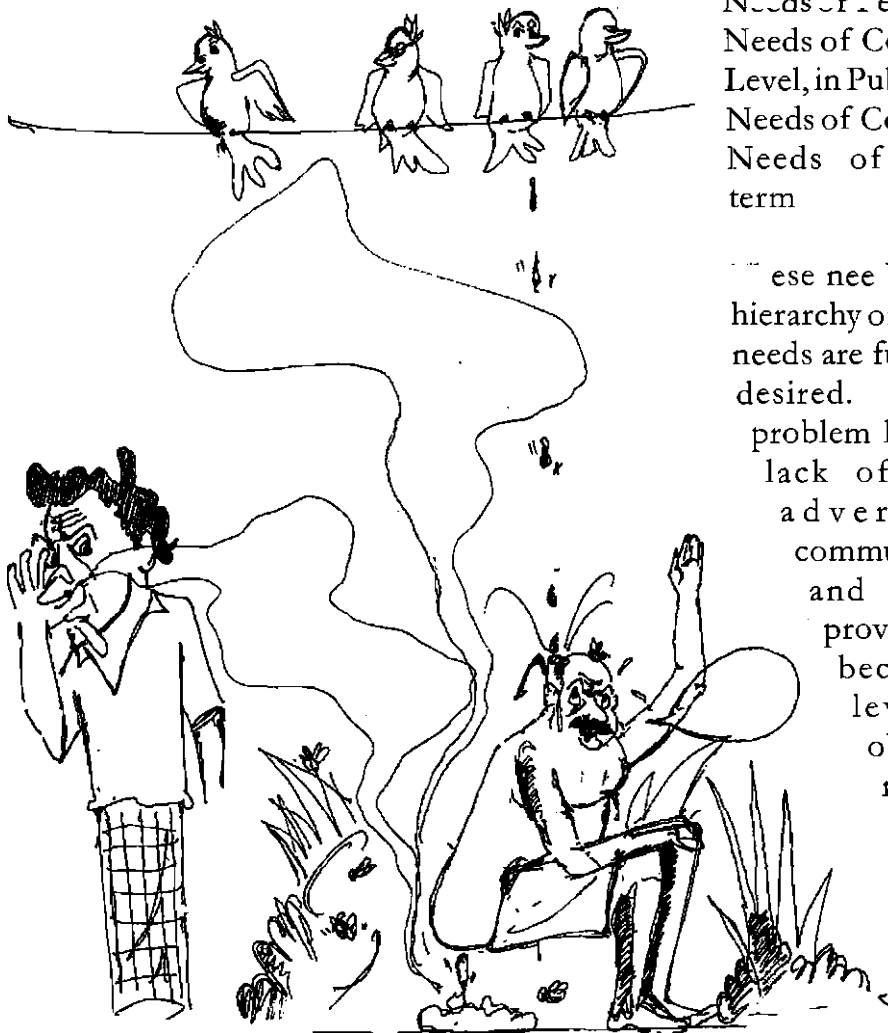

Needs of Privacy

Needs of Personal Hygiene

Needs of Convenience, Household Level, in Public Institutions

Needs of Community Hygiene

Needs of Environment/Long term

These needs are like the Maslow's hierarchy of needs, as the base level needs are fulfilled, the next level is desired. However the main problem lies in the fact that the lack of sanitation affects adversely the entire community, in terms of health and environment. Thus providing sanitation for all becomes a community level, national level obligation and planetary necessity.

Thus the task of a solutions provider is much more complex than a narrow technical

one. Our technical solutions must at least attempt to cover all levels of needs as the poor cannot be expected to think of the higher levels of need. Education and Information (as envisaged in the Total Sanitation Programme) for the users is essential, but not sufficient. And this is where the Government's new so called "demand oriented approach" as spelt out in the latest draft plan, falls short. A toilet subsidy for BPL families will only ensure incomplete or at least sub-standard and unhygienic toilets. Even lower middle classes find it more convenient to just make a simple pit, and forget about even basic cleanliness.

There are also other factors which are cultural and ritualistic.

All these factors given below need to be taken into account when planning, and designing an appropriate system.

Cultural

User's profile: age, gender distribution, cultural practices, beliefs.

Cultural issue relating to waste handling like caste

Availability of water, and rituals associated with notions of contamination of water

Urination and defecation habits, - our people generally squat, urination - standing or sitting

Resources

Nature of Government programmes/schemes in the district: Resources like finance, subsidy, equipment, support services being provided

Existing expertise on sanitation, masons

Agency responsible for the maintenance / skills maintenance agency

Open space available within the individual plot

Extent of public land available within the site where the houses are constructed for STP

Existing systems

Existing sanitation systems, neighbouring systems

Availability of sewage system, effluent water outlet,

Nature of Sewage treatment of the head, nature of waste water treatment

Waste dumps and places for disposal of solid wastes

Environment

Proximity to wells, surface water sources, water storage sites,

Ground water levels, position, underground water flows

Nature of rain and surface water flow and run off

Type of earth/ground in terms of porosity, hard bed/ Type of substrata

Soil type and agricultural requirements

(taken from : India Water Supply And Sanitation : Background Paper Urban Water Supply and Sanitation. www.worldbank.org. February 2006.

[C.eldoc1/sanitation/WorldBank_BG_Urban_20Feb06.pdf])

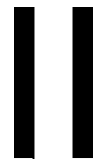

Waste

What is waste? Waste is essentially bio-mass of human excreta, sewage sludge, septage, and slaughterhouse waste.

These wastes can contain large levels of pathogens and chemical contaminants that at these concentrations are hazardous to human health and the environment. However, these wastes do contain significant nutrients, food value. If handled correctly, the biomass can be used for energy recovery or converted to fertiliser.

UNDERSTANDING WASTE

What is waste? Waste is essentially bio-mass of human excreta, sewage sludge, septage, and slaughterhouse waste.

These wastes can contain large levels of pathogens and chemical contaminants that at these concentrations are hazardous to human health and the environment. However, these wastes do contain significant nutrients, food value. If handled correctly, the biomass can be used for energy recovery or converted to fertiliser.

Human excreta is made up of urine and faeces. Humans produce 120-200 grams of excreta per day. It consists of 80% water and the rest is mostly organic matter. Those having toilets generally add a lot more water by mixing it with Urine, washing ourselves, as well as washing the toilet. Those who do not, generally leave it to the nature to take care of it.

FAECES

Human faeces naturally contains high amounts of bacteria. It also contains pathogenic bacteria, viruses, protozoa or helminthes. Thus many diseases get transmitted through faeces. Because of this it is considered a problem and a risk to handle. Therefore waste disposal and sanitary systems have increasingly tried to reduce human contact with faeces.

Most of the 2,00,000 tonnes of faeces that we produce every day ultimately finds its way to water bodies like river and the sea. Even though there we have effluent treatment plants, at a high cost to the exchequer, there is still large scale contamination. We have ended up contaminating ground water, and the sea.

On the other hand if we look at this waste as nutrients, it could help us increase food security and agriculture. Human faeces are rich in phosphorous, potassium and organic matter. Thus they make good soil conditioning material. In fact, by failing to return natural fertilisers, such as human excreta, back to the land, we are depleting soils of nutrients, resulting in the use of artificial fertilisers, and the increased use of pesticides..

URINE?

Urine is a by-product from the body's function of balancing liquid and salts. The average person produces about 500 litres of urine per year.

Urine is generally sterile, though it contains some bacteria after excretion. Cystitis, typhoid fever, schistosomiasis or leptospirosis can be transmitted through urine.

Urine is a high quality, low-cost alternative to commercial fertilizers. It is especially rich in nitrogen and also contains substantial amounts of phosphorus and potassium. According to estimates if urine of about 30 crore people in India who have toilets could be collected, it can produce 1.65 million tones of fertilizers valued about Rs. 800 crores per annum.

Estimated excretion of nutrients per capita in India

(from Jönsson & Vinnerås, 2004)

Total Nitrogen (in kg/cap, yr) - 2.7

Total Phosphorous 0.4

Nitrogen in urine- 2.3

Nitrogen in faeces- 0.3

Phosphorous in urine- 0.3

Phosphorous in faeces- 0.1

Source: www.ecosanres.org

Thus we can see that what we consider waste, does contain essential nutrients which if ploughed back into the soil is extremely beneficial. The World Health Organisation (WHO) has declared that Soil is a natural sanitization system, but provided that 1. The persons handling the waste should have adequate protection. 2. The waste should be covered by 25 cm of soil and 3. No root crops should be planted (WHO, 1989).



Further reading

Ecological Sanitation: Revised and Enlarged Edition. Stockholm Environment Institute, 2004
[http://63.166.104.204/sei/seipubs.nsf/147c0a6246fd7421c12566030073fbb3/8533aa01734f988bc125703600300808/\\$FILE/Ecological%20Sanitation%202004.pdf](http://63.166.104.204/sei/seipubs.nsf/147c0a6246fd7421c12566030073fbb3/8533aa01734f988bc125703600300808/$FILE/Ecological%20Sanitation%202004.pdf)
[C.eldoc1/d70d/undp1_040101zzz2B.pdf]

FAECES TO FERTILISER!

After collecting the human waste, the first task before us is to destroy the harmful bacteria and pathogens. The Pathogens such as protozoa and viruses will decrease naturally since they are not able to multiply outside the host, but bacteria may continue to multiply or get destroyed depending on the conditions such as heat, pH, moisture, solar radiation/UV-light, nutrient availability and presence of other micro-organisms.

Treatment of Faeces

There are two ways of converting waste to manure: Desiccating or dehydrating and Composting. In extreme case, incineration is also used.

De-water (Dehydration)

Given the above factors, the first step is to reduce the amount of water in the excreta.

Factors that affect the survival of micro-organisms in the environment¹

Temperature	AT 55-65 degree Celsius most types of pathogens (except bacterial spores) will die within hours
pH	AT pH 12 inactivation of microorganisms is rapid
Ammonia	Addition of ammonia will inactivate the Pathogens in excreta
Dryness	Dryness will reduce the number of pathogens since it is unfavorable
Solar Radiation	The survival time of pathogens on soil and crop surfaces will be reduced by UV radiations
Other organisms	Different types of pathogens affect other by predation, release of antagonistic substances or competition for nutrients
Nutrients	Competition with other organisms may limit the ability of faecal bacteria to reproduce and survive
Oxygen	Since most enteric bacteria are anaerobic, they are likely to be out-competed by other organisms in an aerobic environment

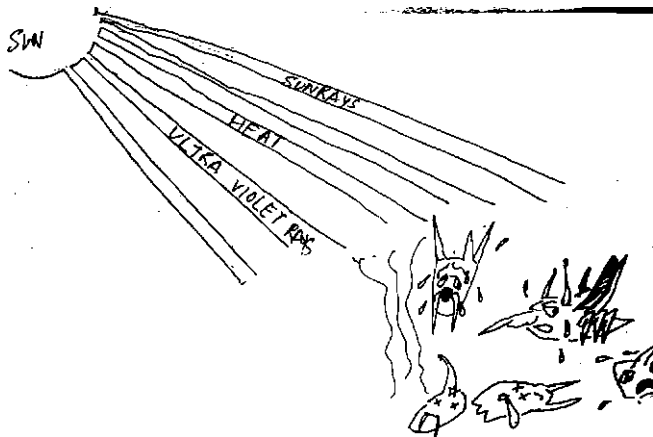

In most pit latrines, the chamber is made porous, to filter out water, and dry up the excreta. The faecus is also contained in the chamber for sometime, till its pathogen content is reduced. The higher the quantity of water, the more time this process takes. This means that the design of the pit should be such that it can filter out the water, as well as contain the

faeces, and ensure that it does not become a breeding ground for mosquitoes and new pathogens.

Alkaline treatment : Adding ash or lime after defecation will lower the moisture content and raise the pH and ammonia level, thus creating unfavourable conditions for pathogens. This also reduces odour and the risk of attracting flies.

At least 1-2 cups (200-500 ml) of ash and/or lime should be added after each defecation (or enough to cover the faeces). Urea is an additive used for elevating the pH level of faeces. It also adds to the fertilizer value. A pH of over 9 for at

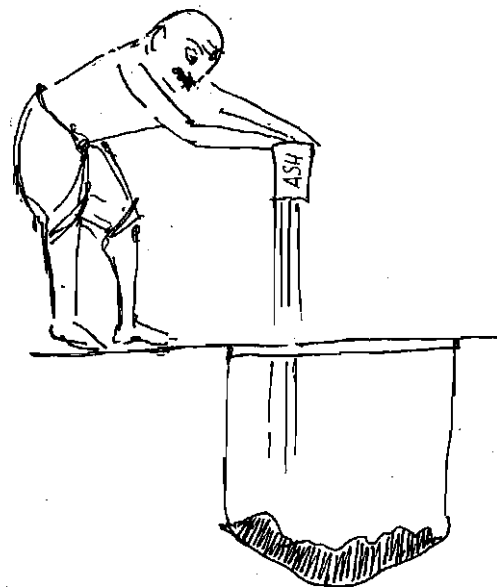

least 6 months will kill most pathogenic organisms. At a higher pH, the drying time period can be reduced. The product from a dehydration process is a kind of mulch, rich in humus, carbon, fibrous material, phosphorous and potassium. It should be stored, sun-dried or composted in order to kill off all pathogens.

Secondary Treatment:

Secondary treatment of faeces may be required to make human faeces safe enough to return to the soil. Secondary treatment includes high temperature composting, chemical addition of urea and longer storage times.

Technical Details

Sanitized faeces should be applied prior to planting or sowing as the high phosphorus content is beneficial for root formation.

If there is a limited amount of faeces fertilizer, it can be applied in holes or furrows close to the plants.

Treated faeces should be worked well into the soil, and not left on the surface.

Treated faeces should not be used for vegetables, fruit or root crops that will be consumed raw.

Precautions such as wearing gloves and thorough hand washing should be followed by the person handling the excreta.

A period of at least one month between application and harvest is recommended for treated faeces. This will further reduce the risk of pathogens due to microbial activity in the soil, UV-radiation from the sun, and desiccation. This one month period also is needed for the crops to utilise the nutrients.

Application rate for faeces

The application rate of faeces can be based on local recommendations for the use of phosphorus-based fertilizers and analysis of the phosphorus content of the faecal product. The average person produces around 50 liters of faeces each year. This amount of faeces will fertilize 1.5-3.0 m² of crop if the application is made according to organic content. If application is instead based on phosphorus content, it will be enough to fertilise 200-300 m².

Faeces are often applied at much higher rates, at which the structure and water-holding capacity of the soil are also visibly improved. Organic matter and ash are often added to the faeces during collection and processing. These additions will improve the buffering capacity and the pH of the soil, which is especially important on soils with low pH.

Important: These guidelines should be adapted to the local conditions

Further reading:

Reuse of Faeces and Urine from Ecological Sanitation. Practical Action, UK by *Niall Boot* in November 2007.
[C.eldoc1/d70d/reuse-faeces-urine.pdf]

Guidelines for the Safe Use of Urine and Faeces in Ecological Sanitation Systems: EcoSanRes Fact Sheet 5.
http://www.ecosanres.org/pdf_files/Fact_sheets/ESR5lowres.pdf.
[C.eldoc1/d70d/undp1_050401zzz1B.pdf]

Guidelines on the Use of Urine and Faeces in Crop Production. EcoSanRes Fact Sheet 6
http://www.ecosanres.org/pdf_files/Fact_sheets/ESR6lowres.pdf
[C.eldoc1/d70d/undp1_050401zzz2B.pdf]

USING URINE

Urine is generally sterile, though it contains some bacteria after excretion. A few diseases can be transmitted like cystitis, typhoid fever, schistosomiasis or leptospirosis through urine.

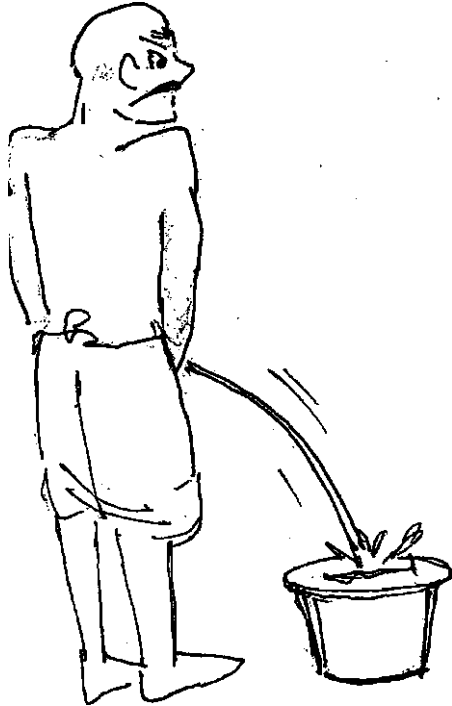

The bacteria in urine usually die rather quickly and do not pose any threat to further utilisation of urine. Therefore it is largely sufficient to observe a withdrawal period before utilising the urine. The wait period is essential if you know that people suffering from the above mentioned diseases have utilised the latrine.

Usually the problem is not urine itself but solid excrement that has accidentally mixed with urine

Treatment of urine prior to use as fertilizer

No major treatment is required for household use of urine as a fertiliser that is when the crops grown are consumed within the family. This is because risk of adverse transmission between family is low. Further, if and when any family member is infected with disease, such urine could easily be isolated. The only

condition is that the last application of Urine must be at least one month prior to harvesting.

For larger systems however, it is recommended that the Urine is stored between 4°C and 20°C for 1 to 6 months, depending on the type of crop to be fertilized. For higher levels of contamination, longer storage time and/or higher temperature. Store undiluted to provide a harsh environment for pathogens, and in a sealed container to prevent loss of nitrogen.

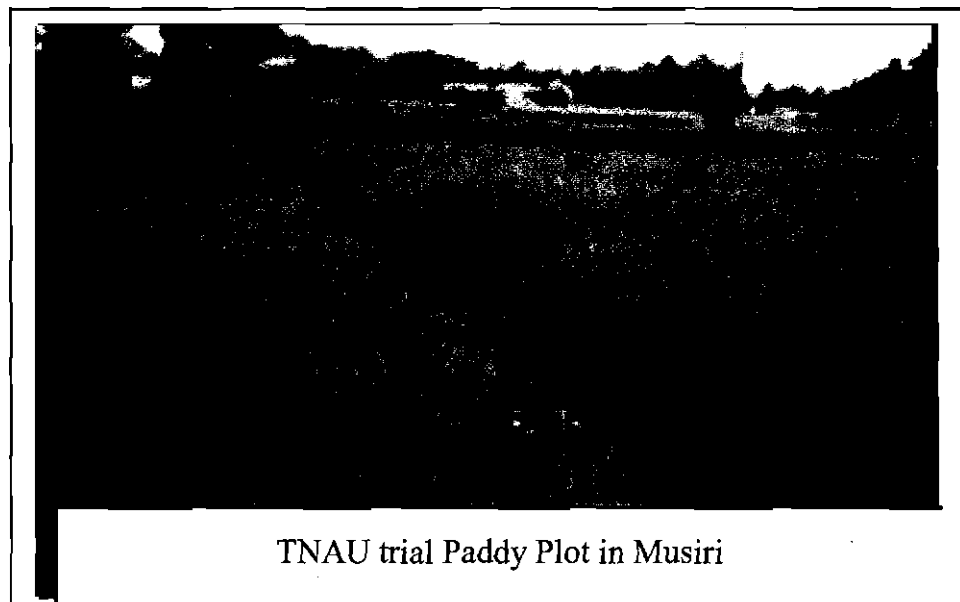

TNAU trial Paddy Plot in Musiri

How to use Urine as a fertilizer

1. Undiluted before or at sowing / planting or to the young plant.
2. One large dose or several smaller ones during the cropping season.
3. Mixed with water as a liquid food.
4. Diluted urine can be added to the soil where vegetables (an plants like maize) are growing once a week or even twice or three times a week, provided that the plants are also watered frequently at other times.
5. Undiluted to soil beds before planting. Bacteria in the soil change the urea into nitrate which can be used by the plants.
6. As an 'activator' for compost heaps. The transformed organic nitrogen will be available to plants when the compost has matured.
7. Concentrated fermented urine can be applied to beds of dried leaf mold, as a Medium for growing vegetables and ornamental plants.



The Tamil Nadu Agricultural Univeristy is doing a two year study on the potential of source separated human urine as liquid on fertilizer crop from Oct. 2007, in Musiri. Details available with SCOPE.

Urine application rate-Rule of thumb

If available, local recommendations for commercial mineral fertilizers, urea or ammonium, can be translated to the use of urine. The nitrogen (N) concentration of urine should be analysed. Otherwise it can be estimated at 3-7 g N per liter.

If no recommendations are available, a general rule of thumb is to apply the urine produced by one person during one day (24 hours) to one square meter of land per growing season (crop). The urine from one person will thus be enough to fertilize 300-400 m² of crop per year and even up to 600 m², if dosed to replace the phosphorus removed by the crop.

Important: For most crops, the maximum application rate before risking toxic effects is at least four times the dose above.

After Crop trials in Africa, Peter Morgan has suggested the following formula for using urine as a fertilizer.

SPINACH : 0.5 liters of a 3:1 water and urine mix applied twice a week. The spinach plants fed with diluted urine weighed 3.4 times more than spinach fed with only water.

MINT & PASSION FRUIT : A weekly application of a 5:1 mix produces a significant increase in growth. This can be stepped up to two applications a week. Normally 0.5 liters of the mix per container is sufficient.

ONION : After six months of water and urine treatment in a 10 liters cement basin the growth and quality of the onions was very good. An amount of 0.5 liters of a 5:1 mix of water to urine was applied once a week during the six-month period together with intermediate watering.

MAIZE : Maize grows very well in the presence of Nitrogen content in the soil. The application of a 3:1 mix of water and urine, once or twice or even three times a week on maize grown in 10 liter containers is very effective.
Source: http://www.ecosanres.org/pdf_files/Fact_sheets/ESR6lowres.pdf

Urine as Pesticide

Cattle urine can be used as a pesticide against insects, anti-viral agents, for instance against leaf curl in chillies (capsicum), and as an anti-fungal agent. A quantity of cattle urine is filtered and diluted in the ratio 1:6 and sprayed on the plants both as a cure and as a preventive. This mixture could be stronger for hardier plants like citrus and for paddy. Cattle urine can kill the red and black beetle that attacks young coconut plants.

Practical recommendations on reuse

1. Urine should be applied close to the ground to avoid aerosol formation, to avoid odour, foliar burns and the loss of ammonia.
2. It should be incorporated into the soil, either mechanically or by subsequent addition of water.
3. The nutrients are best utilized if the urine is applied prior to sowing and up until two-thirds of the period between sowing and harvest.

For Guidelines on the Use of Urine and Faeces in Crop Production

Toilets That Make Compost : Low-cost, sanitary toilets that produce valuable compost for crops in an Afr can context

[C.eldoc1/d70d/undp1_070101zzz1B.pdf], www.ecosanres.org

Urine Diversion: One Step Towards Sustainable Sanitation by Kvarnstrom, Emilsson & Stintzing, Stockholm Environment Institute Sweden, Jan 2006

[C.eldoc1/d70d/01jan06sei1.pdf], www.ecosanres.org

OTHER WASTES

It is not just the human waste that can be recycled and used as a resource for farming purposes; animal waste can do wonders too! Infact traditionally cow dung cakes have been used as a fuel for cooking. Cow's urine has even been an essential part of the ritual performances for thousands of years. For years the cow dung has been used to line the floors and walls because of its insect repellent properties. In our times it is used to produce biogas and energy.

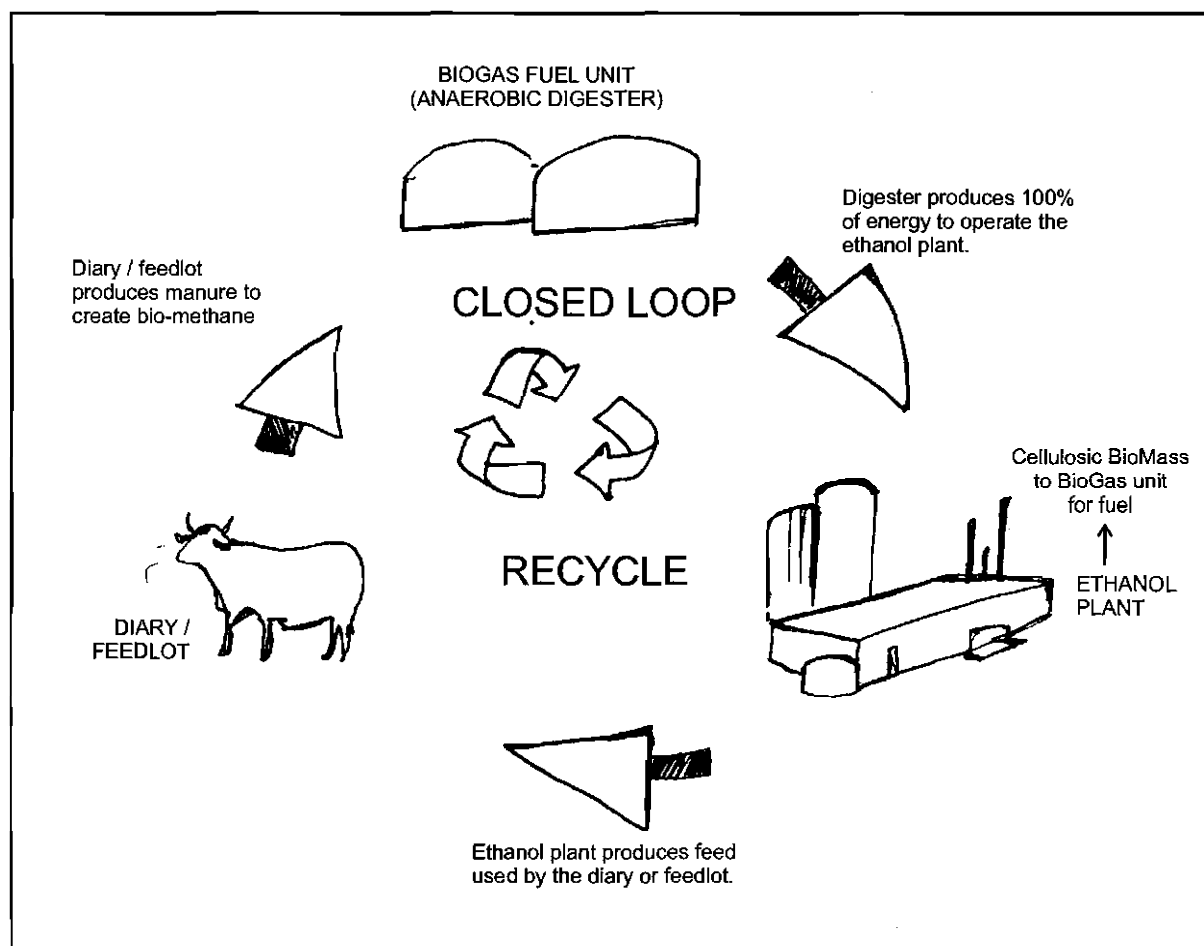

According to the United Nations' Food and Agricultural Organization (FAO), there are about 1.3 billion cattle worldwide (one for every five people), slightly more than 1 billion sheep, around 1 billion pigs, 800 million goats and 17 billion chickens. Between them, they produce a lot of fecal matter -- around 13 billion tons of it a year, according to various estimates. Within that matter is 55 percent to 65 percent methane, which when released into the atmosphere is bad news for us (it traps heat at 23 times the rate that carbon dioxide does) -- but when burned is another matter entirely. It gives us energy.

The equation:

1 pound of cow manure [heated at 28 degrees Celsius] = 1 cubic feet of biogas (enough to cook one day's meals for 4-6 people in India)

* 1 Cow's manure in 1 year converted to methane = fuel provided by 200 liters-plus of gasoline.

7,500 cattle = 1 megawatt (MW) of electricity (1MW can power the average home in the developed world), according to the University of Alberta, Canada. The university also says it would take all of the manure of 6 million cows to fulfill the needs of 1 million homes -- or about six cows per home.

Taken from Animal waste: Future energy, or just hot air? by Rachel Oliver

www.cnn.com

[C.eldoc1/d70d/07jan08cnn1.html]

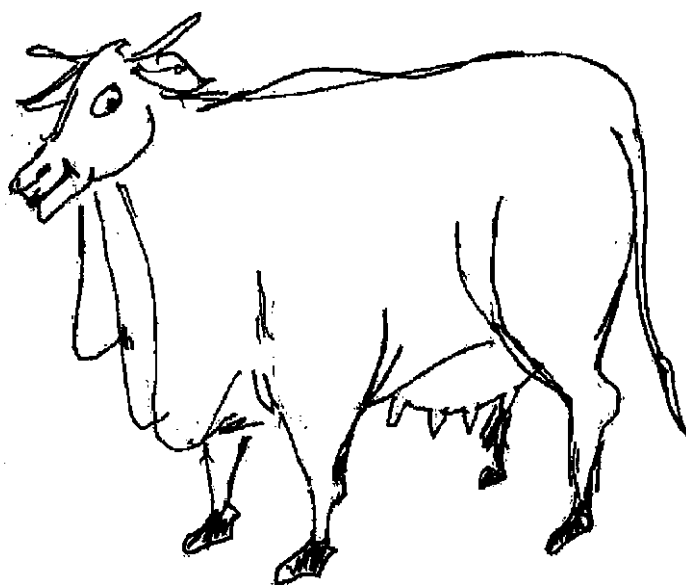

Resources and Further Reading

A Directory of Environmentally Sound Technologies for the Integrated Management of Solid, Liquid and Hazardous Waste for Small Island Developing States (SIDS) in the Pacific Region
Compiled by OPUS International in conjunction with the South Pacific Regional Environment Programme (SPREP) and the South Pacific Applied Geoscience Commission (SOPAC).
July 2002

www.unep.org

[C.eldoc1/d70d/undp1_020701zzz1B.pdf]

Ecological Sanitation : Revised and Enlarged Edition
Stockholm Environment Institute, 2004.

www.sei.se.

[C.eldoc1/d70d/undp1_040101zzz2B.pdf]

COMPOSTING

Composting is an aerobic process in which bacteria and other organisms feed on organic material and decompose it. Composting (one material) and co-composting (two or more materials) represent generally accepted procedures to treat excreta.

Technical Details

To start the composting process, the blended compostable material is placed in windrows (long or round piles). The 'recipe' combines high-carbon and high-nitrogen materials. Air is added to maintain aerobic conditions, either by turning the windrows or by forcing air through them. To adequately treat excreta together with other organic materials in windrows, the WHO (1989) recommends active windrow co-composting with other organic materials for one month at 55-60°C, followed by two to four months curing to stabilise the compost. This achieves an acceptable level of pathogen kill for targeted health values. Adding excreta, especially urine, to household organics produces compost with a higher nutrient value (N-P-K) than compost produced only from kitchen and garden wastes. Co-composting integrates excreta and solid waste management, optimizing efficiency.

- Co-composting with organic household waste is an option.
- It is important to turn the material a number of times for it to be evenly heated and allow complete maturation of the compost

Treatment by Dehydration

In double vault dehydration systems, excreta will partly dry inside the vault as a result of sun radiation, natural evaporation and ventilation. Absorbents such as lime, ash or dry soil should be added to the chamber after each defecation in order to absorb moisture, making the pile less compact.

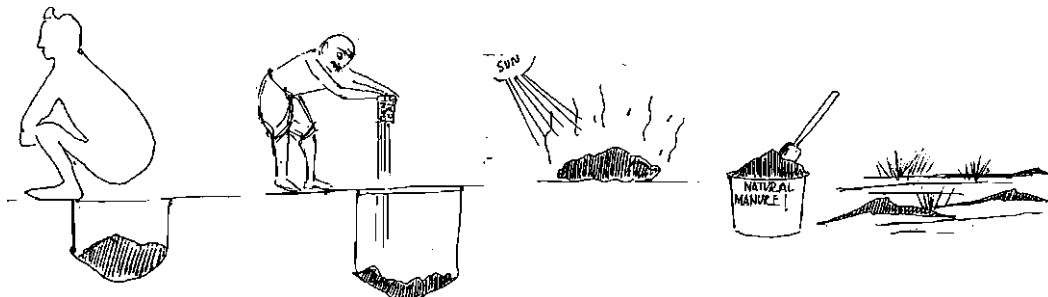

Treatment by anaerobic digestion

In a digestion process, organic matter from human, animal or vegetable waste is broken down by microbiological activity, in the absence of air. This anaerobic process produces a combustible gas, methane, a source of (biogas) energy. The digestion process takes a couple of weeks to a couple of months after which the remaining slurry can be removed, either continuously or batch-wise. A domestic anaerobic digestion technique 'fixed dome type' consists of a simple biogas tank with a flat bottom and a round chamber covered with a dome shaped concrete gasholder. The gas is captured in the upper part of the digester. Gas pressure increases with the volume of gas stored, pushing the slurry into a separate outlet tank.

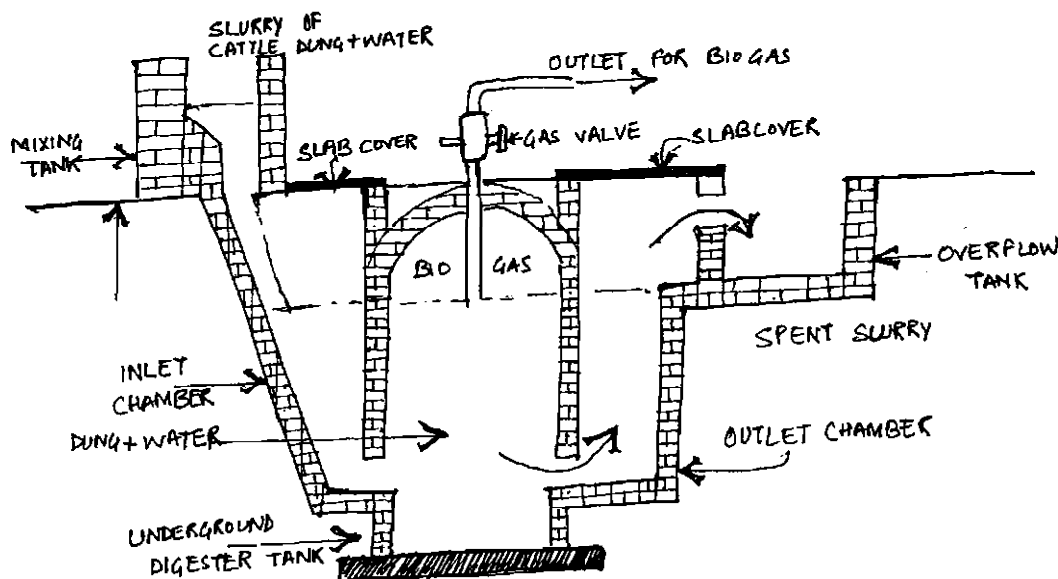

Smart Sanitation Solutions Examples of innovative, low-cost technologies for toilets, collection, transportation, treatment and use of sanitation products. [C.eldoc1/d70d/undp1-060101zzz2B.pdf]

Closing The Loop: Ecological Sanitation for Food Security. Steven Esrey & Others. UNDP/SIDA, January 2001. www.ecosanres.org [C.eldoc1/d70d/closing_the_loop_ecological_sanitation_sida.pdf]

Evaluating Ecological Sanitation - A Sociotechnical Approach by Ketil Haarstad, Henrik Lystad and William Warner. Internet Dialogue on Ecological Sanitation, 2001. www.ias.unu.edu [C.eldoc1/d70d/Evaluating_Ecological_sanitation.html]

Health Aspects of Ecological Sanitation - Aussie Austin. Internet Dialogue on Ecological Sanitation, 2001. www.ias.unu.edu [C.eldoc1/d70d/Health_Aspects_ecological_sanitation.html]
For a list of contractors for installation of biogas plants refer to Annexure 5-Resources/Organisations



Types of Sanitation Units

At a household level, pits [closed pit, dual pits and ventilated pits] and septic tanks are on-site waste disposal systems.

ONSITE

WET

Septic tank

Pour-flush latrine

DRY

Pit latrine with slab

Composting Latrines

Ventilated improved pit

Ecological Sanitation

The public sewer is considered advanced as it takes the sewage off-site. However this requires heavy investment in terms of collection, transportation, treatment and discharge. However governments seem to be reluctant to take up public sewer projects. Further both treatment and discharge generally fall short of desirable standards. Thus an alternative being considered is the DEWATS/DEWAMS system.

OFF SITE

Public sewer

DEWATS/DEWAMS

For DEWATS & DEWAMS the latrine can also be quite close to the site of the toilet as the system can be designed for cluster housing or a hotel as long as minimal supply of waste is available.

SIMPLE PIT LATRINE

Overview

This toilet technology is based on collection and storage of excreta. The human excreta is considered as an absolute waste; not as a product that can be treated or reused. These types of toilets are commonly used by the poorer segments in society in the developing countries since they are relatively simple and low-cost toilets.

They are made of a latrine superstructure and a hole for defecation. A pit cover slab can be used to reduce odour and hinder flies. The depth of the pit is usually limited by the groundwater table or rocky underground, but an average of 3m depth is common. The underground of the latrine should be water pervious. No sullage treatment is required. The latrine can be used until it is filled up half a meter below the top. Relocation of latrine is usual after the pit is full. Life time depends on the number of users.

Advantages

- 1 unit can serve one or several households.
- Low investment for construction.
- Enables construction without depending on expert inputs.
- Easy operation and maintenance
- Flies and odour eliminated in VIP latrine
- Design is readily available; local materials can be used

Disadvantages

- Potential odour and flies problem in simple pit latrine
- Possibility of groundwater contamination
- Requires re-location of pits once full. Re-location of individual leach-pits difficult in densely populated areas
- Space for relocation and/or desludging of pit required
- Functions only if water use is minimal
- Manual desludging poses health hazard

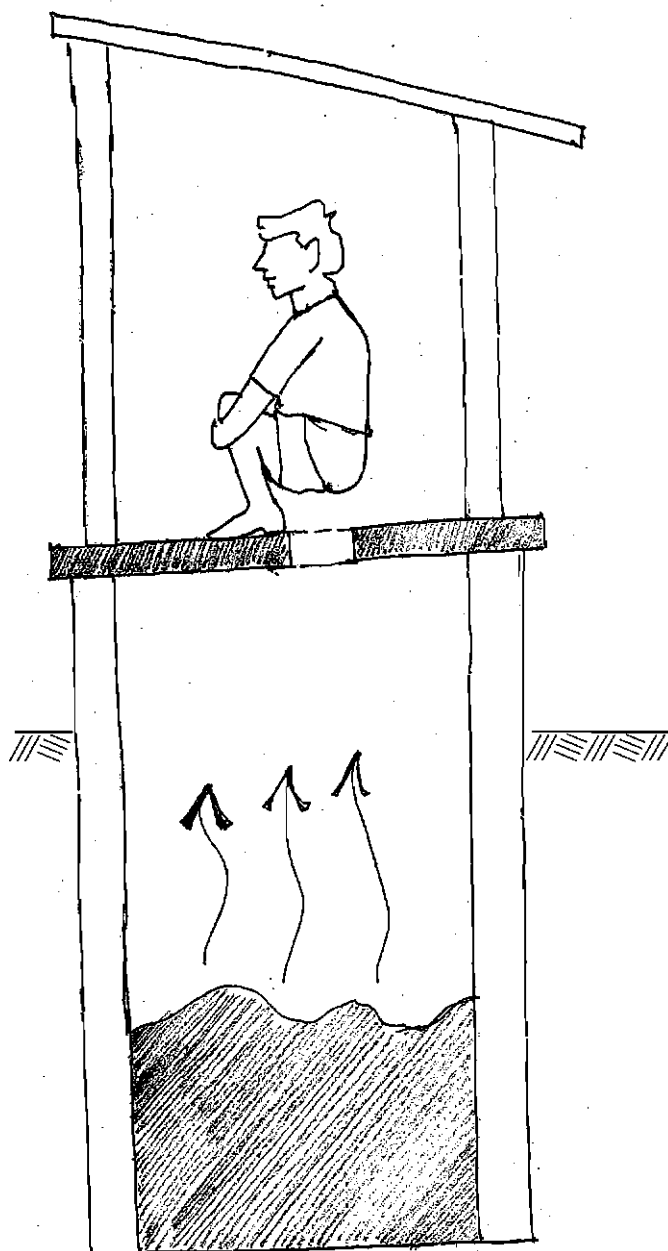

A basic pit with drop hole and lid. The excreta lies here until it gets full, and then sealed.

Design

Pit latrines are designed for the onsite disposal. They consist of a concrete squatting plate or riser, which is placed over an earthen pit.

Pit diameter between - 1 and 1.5 m.

Pit depth- Minimum 3 m deep.

The top (0.5 m of the pit) always requires lining. In loose soil, the entire pit should be lined in order to prevent collapse. The urine and water content of faeces is normally designed to be absorbed into the soil (otherwise the pit will fill up faster). One unit can serve one or several households.

These are easy to operate and maintain. The design life varies, depending on the number of users (several years to 10 years or more)

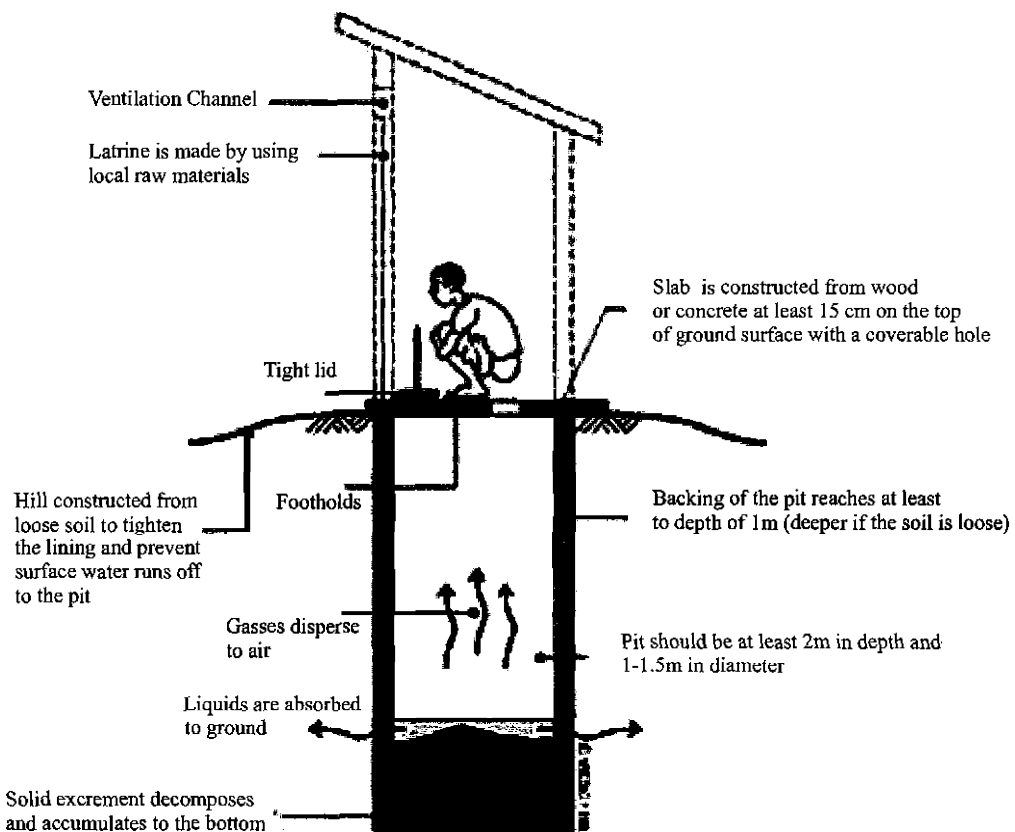

Further Reading

Rural Sanitation Technology Options. Institute of Social Studies Trust,
 [C.eldoc1/d70d/rural-san-tech-option.pdf]

Pit latrines
 [C.eldoc1/d70d/undp1_060913zzz5B.html]

OVERHUNG LATRINES

Overview



An overhung latrine is built above the surface of water bodies like rivers or lakes. From the drop hole in the base the excreta falls straight into water and decomposes there over a period of time. It is usually made of light weight material like bamboo, wood, tin sheets. It may or may not have a roof.

Features

- Practiced in scarcely populated areas with large fresh water body
- Can be built using locally available material
- Cost of construction is minimal
- Easy construction, operation and maintenance
- Supporting wooden parts of superstructure need to be replaced regularly
- Hazardous to health if the water body is small and if is also used as clean source
- The problem is that it is used extensively in all our urban slums located on rivers, drainages.

VENTILATED IMPROVED PIT LATRINE (VIP)

A VIP latrine offers improved sanitation by eliminating flies and smell, through air circulation. The addition of a chimney draws air currents into the structure and through squat hole. Odours rise through the chimney and disperse. The structure of the toilet means that any flies attracted to the pit through the squat hole will try to escape by heading towards the strongest light source, which comes from the chimney. The flies exit is blocked by a wire mesh so the flies eventually die and fall back into the pit.

One can also have a double vault VIP. Only one pit is used at a time. Once the pit is full, the second pit is used and contents of the first one are left to decompose and the second pit used. When the second is close to getting full, the decomposed matter from the first pit is removed.

Advantages

- No skilled labour required for construction and maintenance
- Low capital and operation & maintenance costs.
- Excrements are better contained than in open defecation
- Pit latrines use no water or very little water (in the case of pour-flush latrines) for flushing
- Useful if population density is low, groundwater level is low, area is not prone to flooding and if community cannot afford a better system.

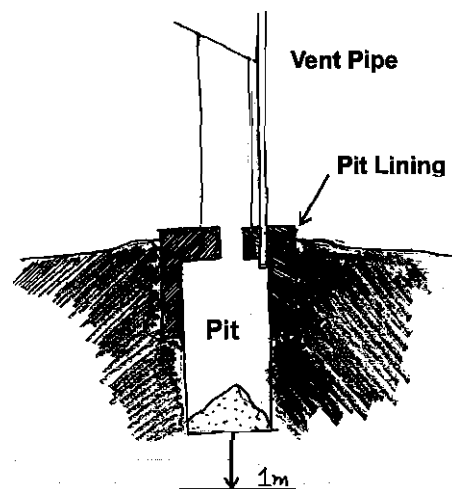

Disadvantages

Since pit latrines involve soil absorption, there is a danger of groundwater contamination

- They cannot be used at all in crowded areas, on rocky ground, where the groundwater level is high or in areas periodically flooded
- Require access to open ground and digging of new pits or emptying of existing ones every few years Emptying of pits can be very difficult (may require manual labour, pits may collapse)
- Usually high level of odour and flies
- Toilets cannot be situated in houses, hence lack of privacy and safety concerns especially during night time

Further readings

Ventilated Improved Pit Latrine.

Practical Action, The Schumacher Centre for Technology & Development.

www.practicalaction.org

[C.eldoc1/d70d/undp1_080220zzz2B.pdf]

The design is the same as that of a pit latrine, consisting of a superstructure, pit cover slab and a hole for defecation. In addition to this it consists of a ventilation pipe with a durable fly screen on the top.

Improvements over : Besides the drop hole with a lid, there is a hole for ventilation, which is covered with a fly screen to prevent inlet of mosquitoes and flies.

Materials needed to make a brick VIP

1. Cement-5 Bags approx
2. Sand- 2 cubic meters approx
3. Aggregate- 1 cubic meter approx [materials used in construction, including sand, gravel, crushed stone, slag, or recycled crushed concrete]
4. Bricks- 1000 of 12.5 X 8 X 5 cm
5. Reinforcement 2 X 8 mm steel bars
6. BRC 610 expanded wire mesh
7. GCI sheets, two 2.5 m long
8. Timber 5cm X 5cm X 12cm long
9. Binding strips 4 m long
10. Building nails- 7.5 cms 1 kg
11. Roofing nails- 0.5 kg
12. Fly screen- 30cm X 30 cm

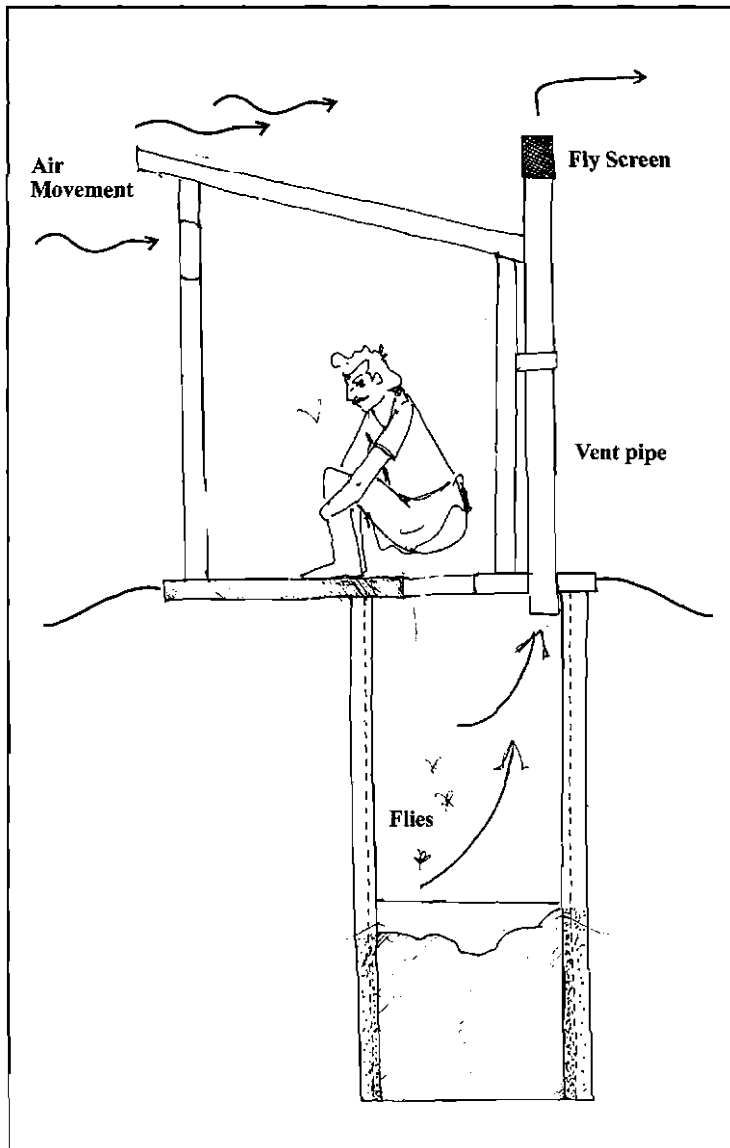

Dos and dont's

1. The latrine should be at least 40 meters away from any water source
2. The doorway of the VIP latrine should face the wind.
3. The latrine should be down wind from the house
4. The pit should be well above the ground water level
5. The pit should be dug at least 3 meters deep; walls should be straight
The deeper the pit is, the longer it will last

A dual pit model is also possible for both VIP and Pour-flush toilet, where pits are used alternatively

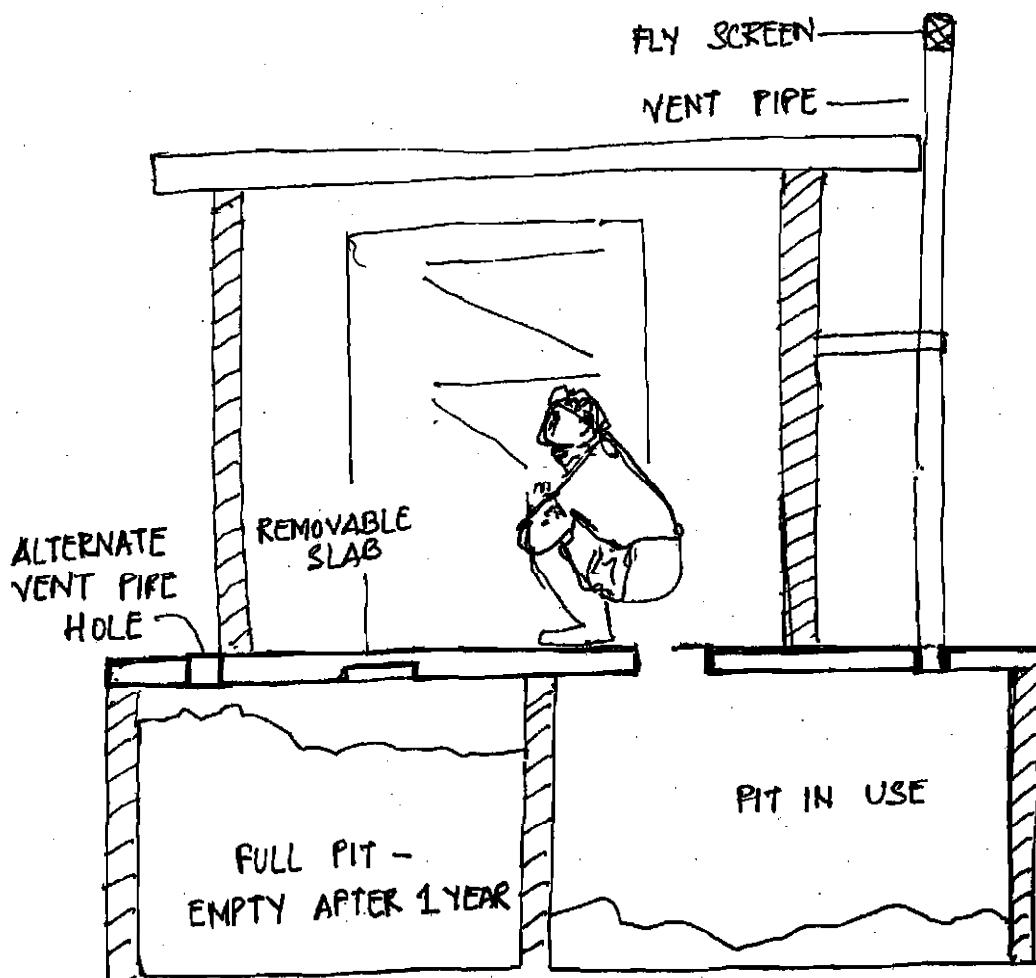

Further Reading

How to Construct a Brick VIP Latrine, A step by step manual for training Public Health Technicians. Edited by Nicholas Greenacre. African Medical and Research Foundation and Kenya Water for Health Organisation. [C.eldoc1/d70d/how-to-construct-VIP-latrine.pdf]

POUR-FLUSH TOILETS

Overview

Manual pour-flush latrines are more common than the cistern based. It has a water seal against odour and insects. Excreta in the latrine pan is flushed by pouring 2-3 litres of water.

A typical pour-flush-leach-pit type latrine is made of a superstructure, a WC pan with water seal, collection pipe, approximately 100mm in diameter, to discharge the waste and water into the pit. For desludging purposes it is better to have the pit off-set and not directly under the superstructure, Desludging is required every 3-5 years. High volumes of sullage discharged into the pit can cause spill over during rainy season.

In dual leach pit pour-flush latrines, one pit can be used while the waste in the other pit is left for further decomposition. Once the pit being used is close to getting full, the decomposed matter from the other pit can be removed and this pit can be used now.

Features:

- One unit can serve one or several households
- Suitable for areas with deep groundwater table areas with adequate water supply
- Low investment and maintenance costs
- Easy operation and maintenance
- The system can be upgraded
- Can be constructed locally using local masons
- Groundwater pollution high due to percolation of water from the pit.
- Manual removal of sludge from the pits regularly.
- Relocation of individual leach-pits very difficult in densely populated areas.

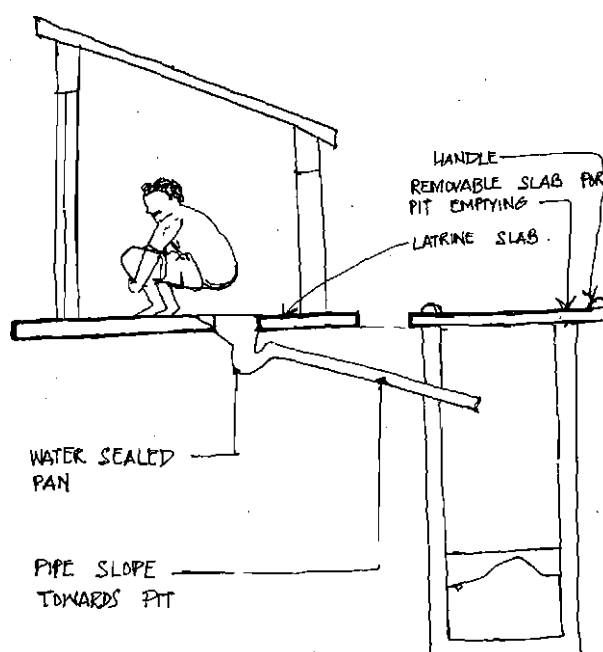

Further Reading :

Manual on the design, construction and maintenance of Low-Cost Pour-Flush Waterseal Latrines in India by *AK. Roy and others*. Technology Advisory Group (TAG)-India. http://www.fastonline.org/CD3WD_40/JF/423/17-406.pdf
[C.eldoc1/d70d/undp1_840101zzz2B.pdf]

Water Flush Toilet

<http://www.schoolsanitation.org/BasicPrinciples/WaterFlushToilets.html>
[C.eldoc1/d70d/undp1_050101zzz3B.html]

Sulabh Technology- Sulabh Shauchalaya (Two pit Pour flush Latrine)

http://www.sulabhenvi.in/pages/database_detail.asp?id=45.
[C.eldoc1/d70d/undp1_080301zzz3B.html]

The structure of pour-flush latrine is similar to that of ventilated improved pit latrine. In pour-flush latrine there is a U-formed water seal, which prevents flies to enter and odours to form. The latrine is flushed with a couple of liters of water after every use. Pour-flush latrine can be used where enough water is available and ground is permeable.

It is particularly useful in places, where use of water is culturally determined, as in India.

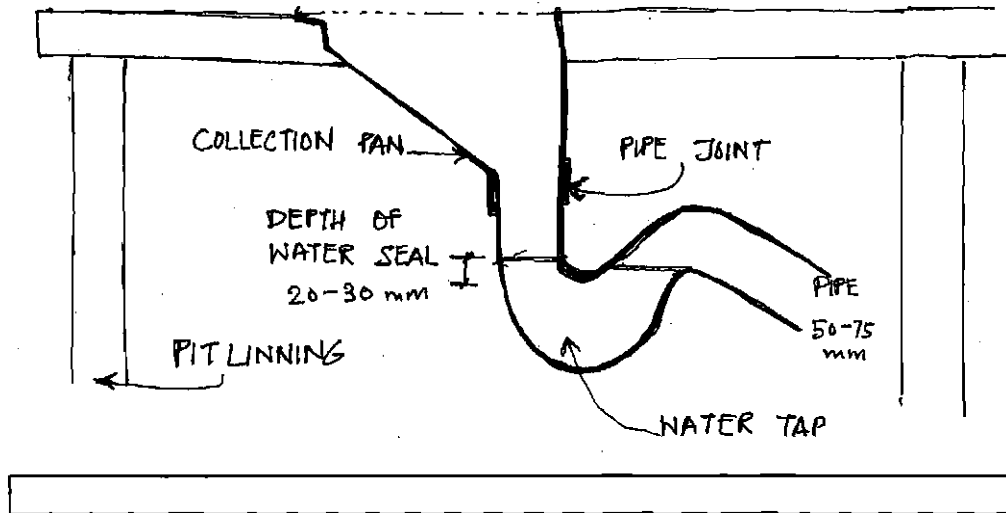

ECOSAN

Overview

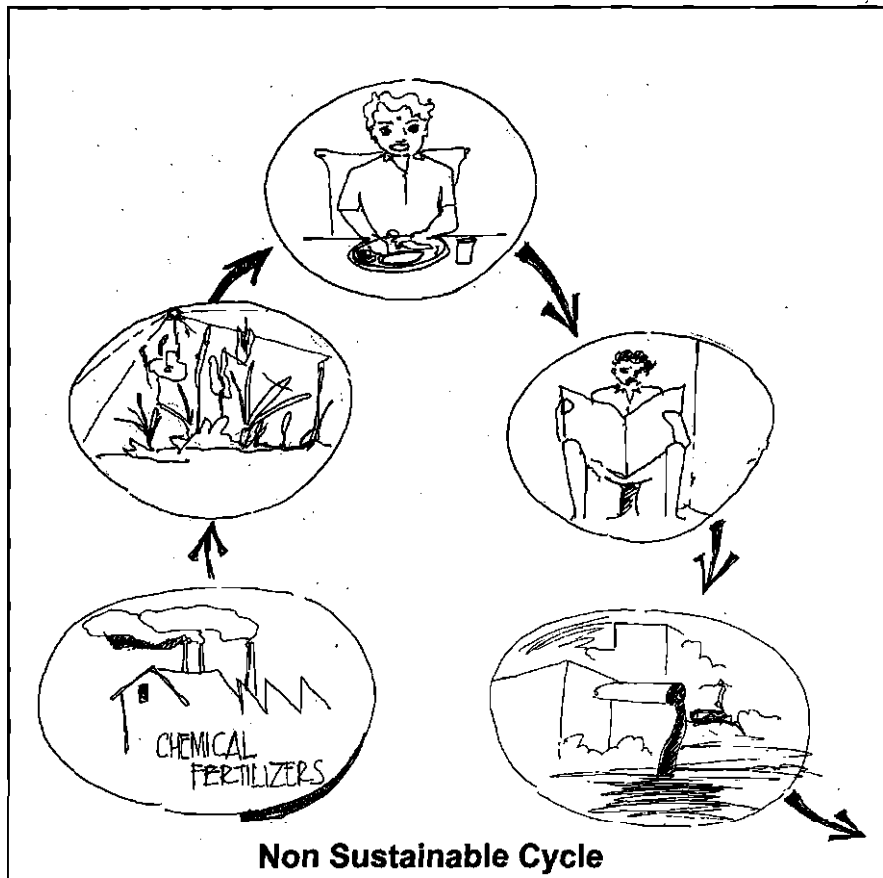

ECOSAN or ECOLOGICAL SANITATION is an approach to sanitation that saves water, does not pollute, and returns the nutrients in human excreta to the soil.

It is called ecological because it seeks to reconnect the natural cycle of food-waste-food which has been broken by conventional sanitation. Plants give nutrition to

herbivores, who serve as food for the animals higher in the food chain. When animals defecate, the unused nutrients are transferred back to soil for the use of plant.

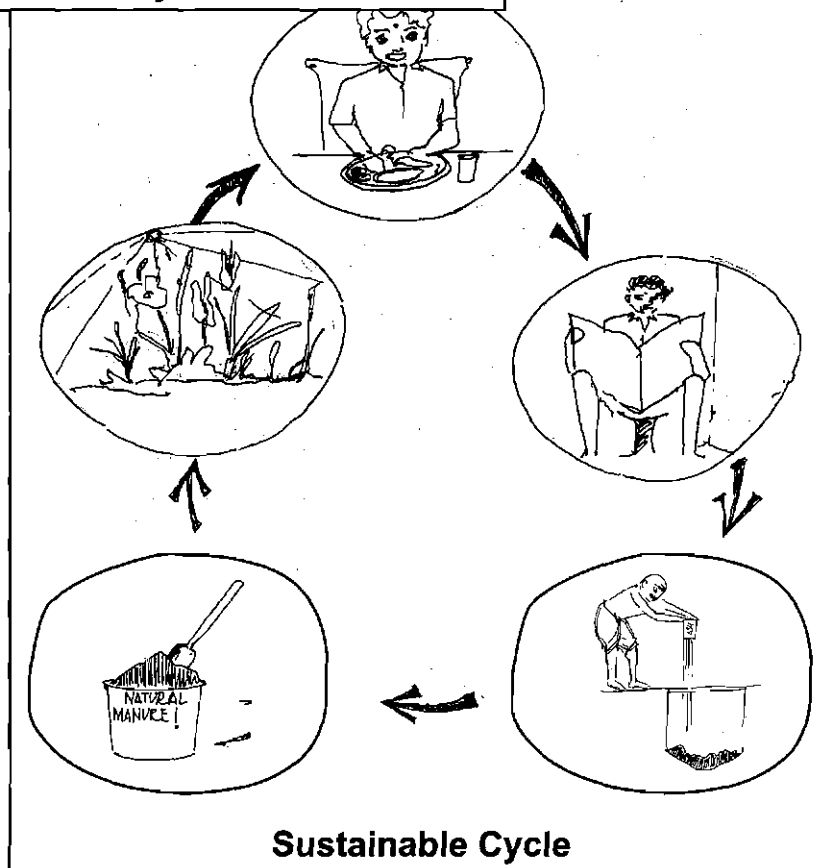

How does it work?

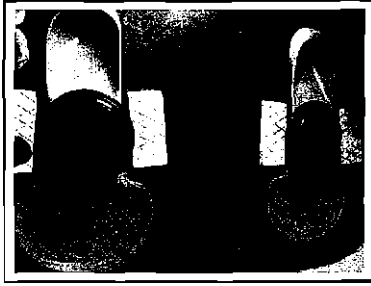

The toilet is designed in such a way that the Urine is separated from the faeces. Further the water used for washing of hands as well as the toilet is separated out and sent to natural filter beds, from where it irrigates a field nearby. The urine is taken

by a separate pipe and stored in a perforated pot to be used as fertiliser. The faeces is kept dry by adding ash and lime, so the time taken to destroy the pathogens is shorter. When the first chamber is full it is sealed up, and the time taken for the next chambers to get filled up is sufficient for the excreta to degrade so that it can be handled safely, without odour, and is ready to use as manure.

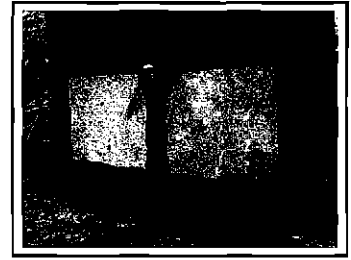

Benefits of ECOSAN toilets

- Prevent ground water contamination as the chambers are kept above ground and fully sealed.
- Ideal for users in water logged, high ground water table areas.
- The unit does not require any type of flushing mechanism, eliminating the risk of mechanical failure. Does not require de-slud in or um in out black water
- It has no sewer connections. Saves water as it does not require any water to carry human waste; no plumbing is required.
- Does not require any treatment of urine or faeces.
- No flies or foul smell. No mosquito breeding as there is no water stagnation.

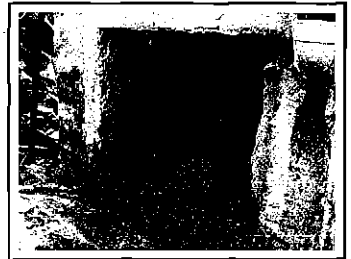

Factors influencing design and management of Ecosan toilets

Climate- temperature, humidity, precipitation, solar radiation. In dry areas it will be the easiest to sanitize faeces through dehydration, whereas composting may be more successful in humid areas

Population density, settlement pattern- the availability of space for on-site/off-site processing, storage and local recycling.

Social/ Cultural- Customs, beliefs, values, practices. Acceptability to reuse human waste for agriculture.

Economic- the financial resources of both individuals and the community as a whole to support the ecosan system

Technical Capacity- the level of technology that can be supported and maintained by local skills and tools

Agriculture- the characteristics of local agriculture and homestead gardening

Institutional Support- legal framework, extent of support for the eco-san concept in government, industry, financial institutions, universities and NGOs.

Applicability of Ecosan

Most NGOs agree that Ecosan is a very good design. But the most important problem is to convince people. It is also very difficult for people who have used flush type of toilets to accept dry compost type of toilets. They also need to make that extra effort to do the job such that they urinate in the proper place and drop their faeces directly into the hole. And then to cover the drop hole, and shift slightly to wash themselves. . It is important to make the people culturally, socially comfortable using Ecosan type of toilets. There is need for regular monitoring and follow up

Thus many NGOs are concentrating on developing improved versions of pit latrines at the individual level. Since correct use of water, namely complete separation of urine and water from faeces, will probably take time and practice, some NGOs have suggested the adaptation of a decentralised water management systems (DEWAMS). The design for this system called DEWATS is taken up more fully in the next chapter.

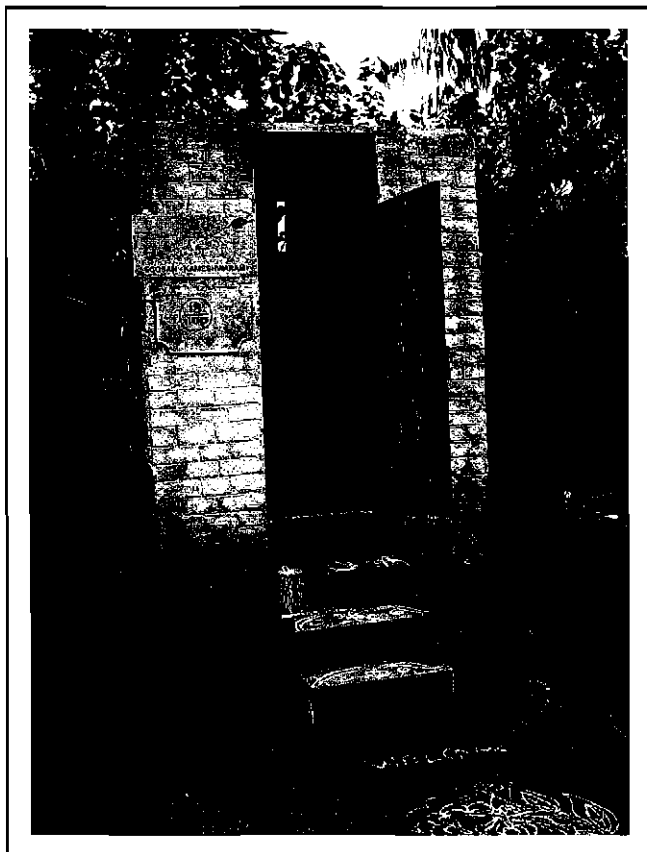
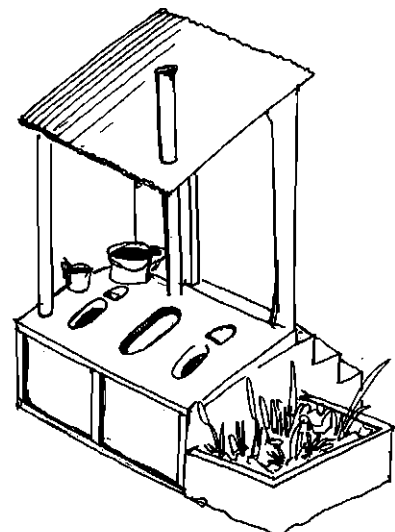

The basic design is shown in this picture. Some of the important elements of the design are:

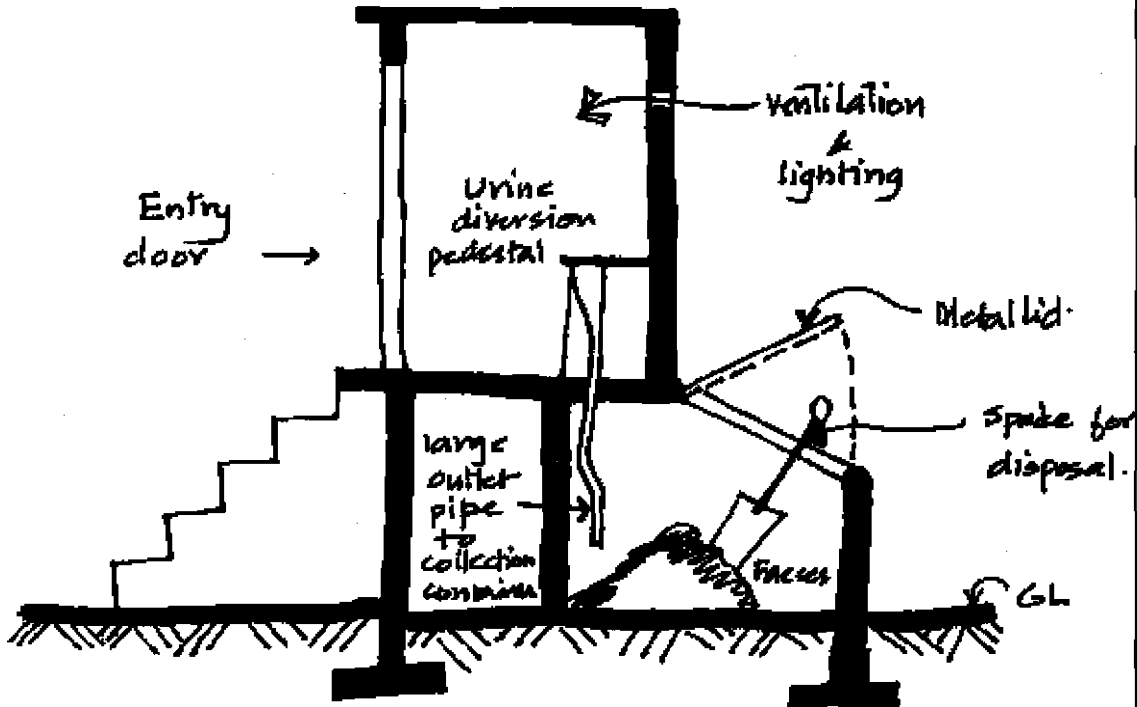

1. The compost toilet should be constructed above ground level.
2. The base of entire toilet should be cemented and made impervious.
3. Separate areas for collection and outlets for urine, wash, and faeces. The urine hole in both chambers should be connected by a pipe and led into the pot with holes. The wastewater in each chamber should be connected by a pipe separately and collected in a filter bed.
4. A vent pipe should be provided at the junction of the separation wall of the two compost chambers to remove the air and gas inside the compost chamber to prevent foul smell inside the toilet. It will quicken the process of the dehydration.
5. The cowl of the vent pipe should be covered with a mosquito net.
6. The door will be fixed 1/2 above the flooring and 1' below the roof, to ensure air circulation.

Materials & Steps for one ECOSAN Compost Toilet

Cement, chips, sand, hollow block, brick, ½ inch (40mm jally) etc. as detailed in the cost estimate given below.

- Vent pipe with cowl (painted in black) 10' long and 3" dia.
- Mud pot (with holes)
- 1" PVC Pipes (15') with necessary accessories
- Two small bucket for water and ash
- Two lids for drop holes

Prefabrication Work

Squatting slabs. Two squatting slabs for each chamber, each resting three sides on the outer wall, and with the partition wall between the two chambers being the fourth. Each squatting slab will have a drop hole in the middle, urine bowl with hole in the front and wash bowl with a hole at the rear. Dimensions of slab: 4'4" x 27"; thickness 2". The Reinforcement used is welded mesh of 4 mm fixed to 6 mm rods 6 mm on all the four sides. The basin mould is fixed (9") from the rear side.

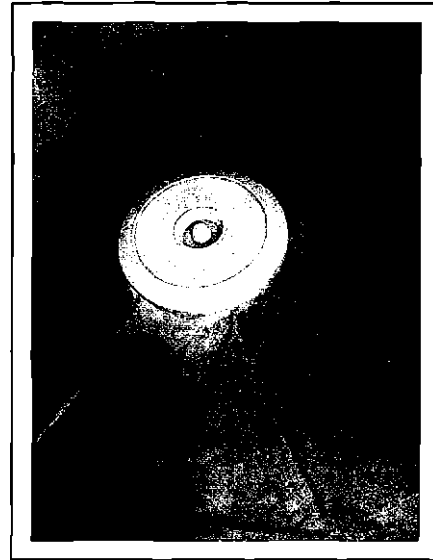

Cement mortar for the slab is 1:3 cement, sand and small {1/2"} blue metal).

A dry mixture of sand and cement should be sprinkled over mortar over which paste cement water is applied. Curing should be allowed for seven days, three days at the fabrication site and another four days in a water tub.

The place where the urine and wash water pipes have to be fixed should be marked at the bottom of the squatting slab.

A Prefabricated SCOPE model squatting slab will have a drop hole in the middle, urine bowl in front and wash water bowl in rear.

Roof slab. Two slabs each 3' x 2.2' x 1" (like Ferro cement slabs)

Detacheable Slabs (2) for chambers is made of 1:5 mortar with an iron handle.

Site Work

Selection of the site is important. It has to be big enough to accommodate the full compost toilet, that is the squatting area as well at the filter bed, and collection pots, with access to chambers for clearing. Size: 5'6" x 4'4". Further a small kitchen garden to where the wash water and urine can be channelled is needed. Mark of toilet including filter bed pit and pit for urine mud pot.



Foundation: Excavate soil upto one and half feet deep. Construct basement with soling (rough) stones with cement mortar 1:8. And then a foundation for six more inches up to the ground level.

Chambers and Plint: The bottom of the chambers is made out of cement concrete. Three vertical sides of the outer walls, the partition wall dividing the chamber into two are first constructed with cement mortar, hollow blocks or bricks upto a height of 2 feet.

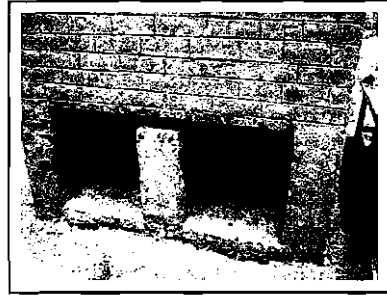

The masonry work is done, making provision for the piping work, namely the one inch PVC pipes connecting to the urine hold in the two slabs, and fixed and connected to the pot outside. Another PVC pipe will connect wash water holes in both chambers to the filter bed. These two pipes should be fixed before the squatting slab is fixed.



The construction is done such that the fourth vertical wall consists of two detachable slabs, such that the slabs fit well and removal of one does not expose the next chamber.

The inner portion of the two chambers should also be given a finish with mortar.



The RCC detachable slab 1:5 mortar with iron handle would be fixed with on the rear portion of the chamber. It could be removed when compost is to be taken out.

The squatting slab could have cement finish, red oxide finish or ceramic tiles.

Superstructure

Super structure can be built with hollow blocks or bricks of 7" feet. Roof is a must to prevent rainwater entering compost chamber. The roof may be Ferro cement or ordinary slab with a slight inclination.



Filter bed and Urine Collection pot



18" x 18" x 18", pipe with 6" diameter to be constructed with brick.

Filtering materials: Bottom layer: rough sand, middle layer 3/4 inch blue metal, top layer: 1 1/2 inch blue metal. Saplings should be planted inside the filter bed.

Filter Bed

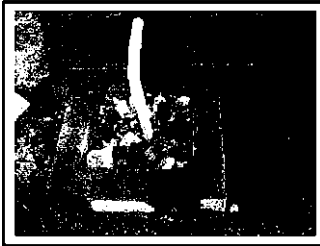

Mud pot should be filled with water and three holes made singly with sharp instrument. It should be buried under the ground and the urine pipe from the HCEST should be within the pot. The pot covered with a lid, which should have a hole in the middle. While burying the pot care should be taken so that the holes should be away from the basement of the toilet. In the vacant site

near the filter bed and urine collection mud pot bit bara a, aaya, coco ut seedlings should be planted.

Pot for urine collection



Improvements/ enhancements

Several improvements and enhancements have been made to the basic design to make the ECOSAN more appropriate. One such innovation is to make the toilet face northward and the detachable slabs at an angle such that the sun's radiation helps in quickening the process of converting the excreta to manure.

The other is using rain water harvesting techniques, and solar panels for providing lighting throughout.

One such design is the Toilet cum Bathroom Complex (TBC) in Kameshwaram panchayat [Nagapattinam]. It consists of one toilet for men and one toilet for women with a bathroom in-between. The rainwater from the two roofs runs off into a tank below the bathroom. The solar panel on top of the gents' bathroom roof supplies power for the TBC. The walls of the ladies toilet and

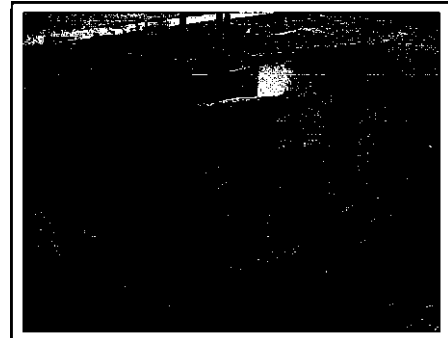

the bathroom are made of locally made country bricks. The gents toilet is made of bamboo. To cover up the gaps between the bamboos and to provide for a smooth interior, the internal surface of the bamboo wall has been lined with recycled gunny (or jute) bags plastered with a lean soil-cement mortar. The roof is lined with clay tiles supported on bamboo rafters. Strip ventilation is achieved with bamboo and brick lattices. The TBC has been constructed at a cost of about Rs 80,000.



Further Readings:

Ecological Sanitation: an Integrated Approach Society for Community Organization and People Education (SCOPE), 02/06/2007.
[C.eldoc1/d70d/Ecosan.pdf]

Toilets That Make Compost. Low-cost, sanitary toilets that produce valuable compost for crops in an African context by Peter Morgan, Stockholm Environment Institute, SWEDEN, January 2007.
http://www.ecosanres.org/pdf_files/ToiletsThatMakeCompost_lowres_grey_scale.pdf
[C.eldoc1/d70d/undp1_070101zzz1B.pdf]

Building Toilets: Action Sheet 26, Paceproject.net.
<http://www.paceproject.net/UserFiles/File/Water/Building%20toilets.pdf>
[C.eldoc1/d70d/undp1_080222zzz1B.pdf]

Ecological Solutions to Flush Toilet Failures [In Tamil & English]
Paul Calvert EcoSolutions, UNDP. [R.D70d.615 a, b]

Ecological Sanitation: Revised and Enlarged Edition, Stockholm Environment Institute-2004. www.sei.se
[C.eldoc1/d70d/undp1_040101zzz2B.pdf]



For details on Ecosan contact:

SCOPE

Society for Community Organisation and Peoples Education

P/17, 6th Cross, Ahmed Colony,

Ramalinga Nagar, Woraiyur, Tiruchy 620 003

Phone : 0431 2774144, 94431 67190

E-mail : scopeagency86@rediffmail.com,

Website : www.scopetrichy.com

For details on TBC contact:

Shayama Ramani, FINT: shyama_ramani@yahoo.com

V. Ganapathy 9443109032

Gita Balakrishnan 9831175272

DEWATS

The most predominant sewer system relies on a Centralised Treatment System in which all the waste water/ effluents generated from sources such as houses, schools, hospitals, industries etc are collected and taken via open or covered drains / sewers to a centralized treatment plant. In most cases, storm water is also drained through these drains. These systems are mostly based on Aerobic treatment procedures. These centralised aerobic systems require large land areas, high power and skilled labour for regular maintenance.

DEWATS or Decentralised Waste Water Treatment System on the other hand attempts at smaller dispersed treatment systems, which are basically anaerobic, with low maintenance. It is now well established that such Decentralised Anaerobic Treatment of

Sewage and Waste water, is suitable for tropical climates like India.

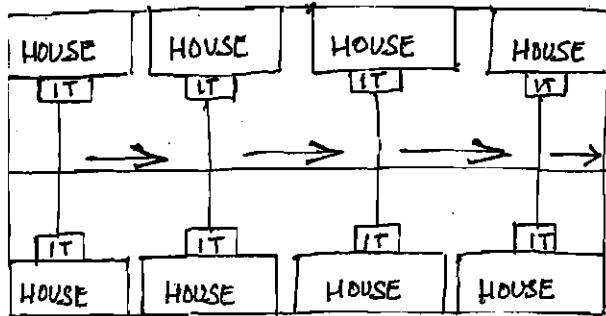

DEWATS is basically not a system to deal with excreta alone. It is part of a larger system to treat and re-cycle wastewater from all domestic and industrial and other sources. DEWATS also does not actually refer to a particular technical design or structure. DEWATS is an

approach that uses several processes to treat wastewater, which is adapted to the local situation.

In Structure, DEWATS works like a sewer system, except the system is decentralised, which makes it simpler in process, technology, and operations and maintenance.

It has three characteristics or rather basic principles on which it is applied:

- Decentralization: Responsibility, Capacity, Treatment.
- Simplification: Process, Technology, O&M (operations & maintenance)
- Conservation Recycling: Water, Nutrients, Energy

DEWATS is based on four treatment systems:

- Sedimentation and primary treatment in settlers, septic tanks or Imhoff tanks.

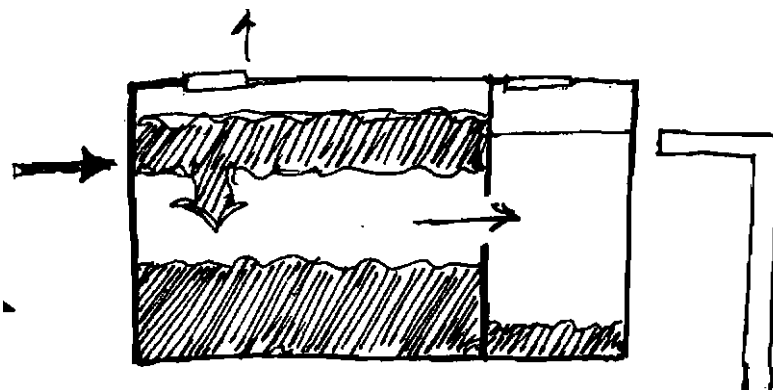

Septic tank / Settler

- Secondary Anaerobic Treatment in Anaerobic Baffled Reactors or Anaerobic Filters.

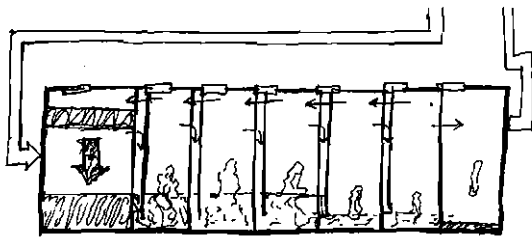

Anaerobic Baffled Reactor

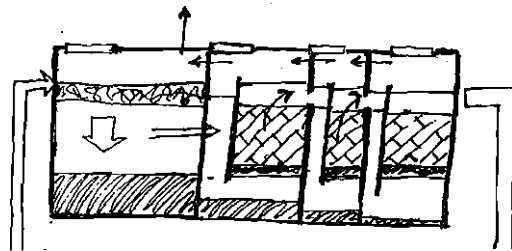

Anaerobic Filter

- Secondary and tertiary aerobic/anaerobic treatment in Planted Gravel Filters.

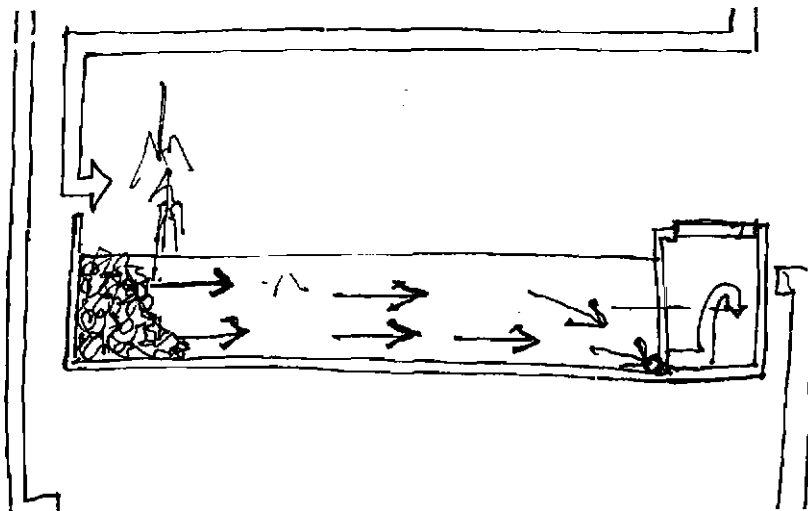

Planted Gravel Filter

- Tertiary anaerobic / aerobic treatment in ponds.

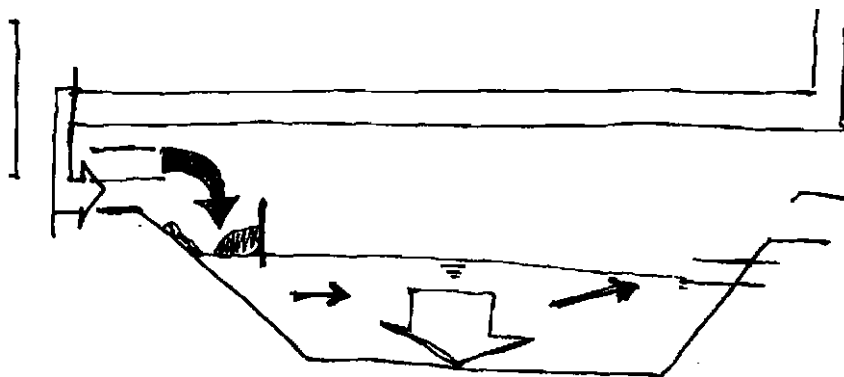

Pond Systems

Pre-treatment is done to eliminate solids by putting in an interceptor tank like a septic tank where all settle-able solids settle. The interceptor tank can be provided for every house or for a cluster depending on space availability

The solid-free effluent is then let into the collection system. The sewers are laid at shallow depth as there is no solid component in the effluent, no regular manholes required. However a clean-out can be provided which can be used to push water to clean up in case of any clogging. Since solids are separated out at the first stage, deep sewer lines are not required

Treatment of this effluent waste is done in decentralised clusters through a variety of secondary and tertiary treatments systems such that the effluent conforms to discharge standards of the Pollution Control Boards. Further the water is such that it can be used for irrigation and other non-portable purposes. The various process are chosen such that the treatment process does not need electricity and they are reliable and durable, requiring minimal maintenance

Since it is decentralised:

The design and nature of treatment can be specific to the nature of waste including domestic and industrial waste.

The waste doesn't have to traverse long distances, distances thereby eliminating huge costs on pipes, pumps and appurtenances.

The main disadvantage of the technology is that it requires space at the local level. Also like all decentralised and locally built options, quality is known to vary.

Model	Cost*	Capacity
Dry compost toilet	Rs 5000 - 6000 per unit cost - usage lifetime	Individual
DEWATS- Ferro cement	Rs 0. 16 / user / day for 30 years (inclusive of maintenance)	500 users (125 households)
DEWATS- Ferro cement	Rs 0. 19 / user / day for 30 years (inclusive of maintenance)	200 users (50 households)
DEWATS - FRP	Rs 0.33 / user / day for 30years (inclusive of maintenance)	1250 users (313 households)

[Taken from ECOSAN Costing. TNTRC Newsletter. www.tntrc.org]

***Costs vary according to local conditions**

Environmental & Site considerations:

A DEWATS system should be designed to suit specific environmental conditions, as well as the kind of waste that one is dealing with. The 'type of site condition' is taken into consideration while choosing the effluent disposal method. And the range of technology has already been developed for different conditions as shown below:

	Normal Site conditions	Difficult Site conditions	Impervious conditions
Subsoil Type	Suitable for percolation	Low permeability	Impervious
Water Table Depth	Deep	High	Very High
Bedrock	Unfractured	High and fractured	High and fractured
Ground Surface Slope	Favourable	Unfavourable	Steep
Flooding	None	Occasional	Frequent
Distance from water supply wells, buildings, escarpments	Far away	Close	Quite close
Lot size	Large	Small	Small
Disposal methods for septic tank effluent	Gravity flow over a conventional percolation trench or bed.	Further treatment needed Periodic dosing of a disposal field by pump or dosing syphon.	Drastic change water conservation, treatment and recycling.

Design of septic tank:

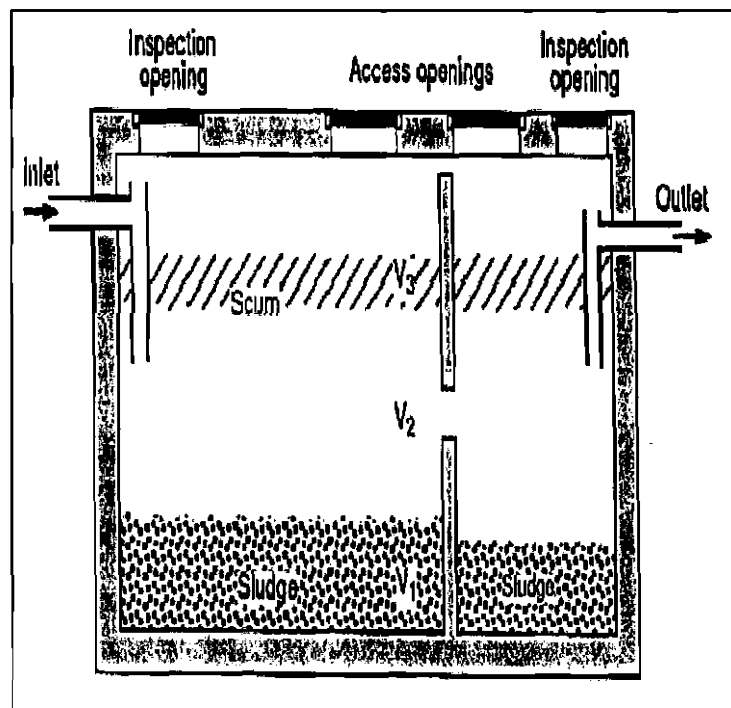

Settler / Septic Tank: The settler is a sub soil constructed tank with one baffle wall. Within the tank, two main treatment processes take place. First, a mechanical treatment retains contaminants by sedimentation/ floatation and the waste water from the clarified layer flows through the outlet.

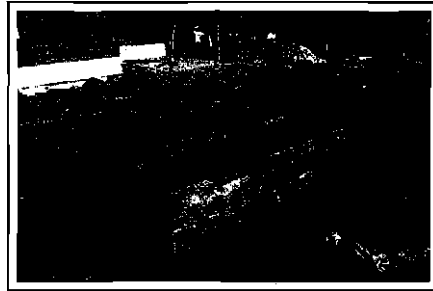

Second, through biological treatment, the remaining organic pollutants are partly decomposed by micro-organisms. Dissolved and suspended matter passes untreated to next stage of treatment. Efficiency is about 25% - 40%.

Through the digestion process the accumulated sludge is stabilized. Storage volume for sludge is generally provided for 18 - 24 months desludging interval. Average reduction of **BOD** [Biological Oxygen Demand]* in the settler is between 20% and 25%. The settlers can be integrated with the baffled reactor.

BOD- is a measure of the oxygen used by microorganisms to decompose organic waste in a water body. When organic matter such as dead plants, manure, sewage, or even food waste is present in a water supply, the bacteria will begin the process of breaking down this waste. When this happens, much of the available dissolved oxygen is consumed by aerobic bacteria.

Bio Gas Settler: This serves as a sedimentation tank for retaining particles.

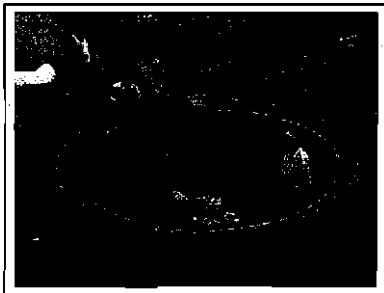

The main treatment process is sedimentation and anaerobic digestion. As wastewater flows into a digester, the heavier solid particles settle down and anaerobic bacteria become active and start digesting organic material in the wastewater. During digestion biogas is formed. The outlet is free from settle able solids. Dissolved and suspended matter passes untreated to the next stage of treatment. Efficiency 25% - 40%.

Desludging period 1 to 3 years depends on sludge storage. Biogas production - Gas storage is needed (gas tight)

Anaerobic Baffle Reactor: The Baffled Reactor consists of a series of chambers in which waste water flows upstream. At the bottom of each chamber, activated sludge is retained. During inflow into the chamber, the waste water is intensively mixed with the sludge whereby it is inoculated with waste water organisms which decompose the contained pollutants.

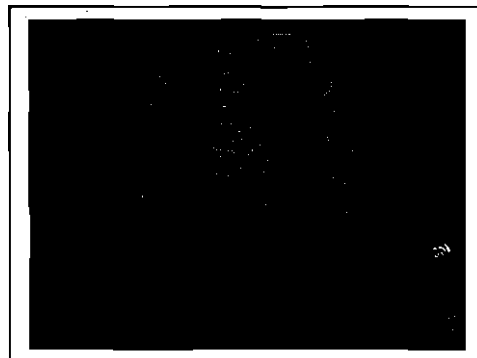

The BOD reduction rate of baffled reactor is about 75% - 85%. The pathogen reduction is in the range of 40% - 75%. The operation and maintenance is simple and no open space is eaten up as it is a sub-soil construction. Desludging is needed only if excess sludge (activated) is generated.

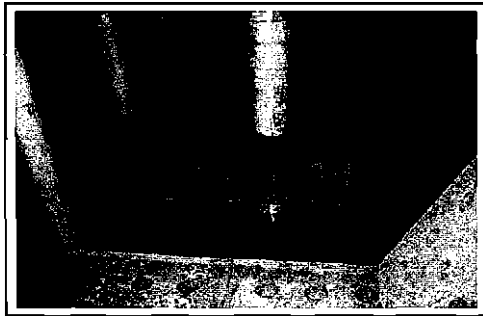

Anaerobic Fixed Bed Filters: The process applies anaerobic organisms for degradation of waste water pollutants. The design is based on continuous upstream flow process, wherein the wastewater passes through a series of chambers through the filter material made out of gravel, slag or plastic elements. Filter media helps increase surface area for active bacteria.

Reduction of BOD is about 70%. The Anaerobic Filter can be integrated with the Baffled Reactor. Efficiency is between 75% - 90%. Desludging is needed only if excess sludge (activated) is generated.

Planted Horizontal Gravel Filter: The Horizontal gravel filter is made of reed planted filter bodies consisting of fine gravel. The filter is permanently soaked in water. The normal depth is 60cm. The main removal mechanisms are biological conversion, physical filtration and chemical adsorption. Mechanisms of BOD removal are mainly aerobic and anoxic. The function of PHGF is mostly post treatment (smell and colour of water) and it can be substituted by planted dispersion trenches.



As an indicator module a polishing pond can be provided after the PHGF. The main purpose of the pond would be oxygen enrichment and elimination of pathogen germs through sun's radiation. Floating aquatic plants can help control algal growth and make it a pleasant landscape feature if desired.

Usage and maintenance of DEWATS [Operation and Maintenance-WEEKLY ONCE]

1. Check each control tank at the communal piping system.
2. Removal of solid waste/ scum from ABR chamber using a shovel and spatula.
3. There will not be proper water flow to control tank if the pipe before it is clogged/broken. STOP using the system, OPEN passage and get the leaks fixed.



4. If the pipe after the control tank is clogged, there will be an overflow. STOP using the system, CLEAR the passage
5. Collect all removals, put solid waste and scum in bags, bring them to garbage collection point. The periodical maintenance will be once in 3 - 5 years
6. Check the Biogas outlet to make sure there is no leakage.

Biogas generated from DEWATS

Biogas is a product of the anaerobic digestion or fermentation of biodegradable materials such as manure, sewage. The methane in biogas gives it the ability to be used as a fuel. The combustion of methane in biogas releases energy and can be used as a low-cost fuel for cooking and lighting. However if biogas being released is minimal or if it is not likely to be used, it should be released in the air by safe ventilation.



Gas Collection and Storage

The biogas is produced within wastewater and sludge, from where it rises in bubbles to the surface. The gas must be collected above the surface and stored until it is ready for use. Gas bubbles cause turbulence which leads to explosive release of gas in a chain reaction. As a result of this, gas production fluctuates by plus/ minus 25 % from one day to the other. The volume of gas storage must provide for this fluctuation.

There are several models of bio gas plant available in India:

1. Floating Dome
 - a. KVIC
 - b. Pragati
 - c. Ganesh

2. Fixed Dome
 - a. Janata Biogas Plant
 - b. Deenbandhu Biogas plant
 - c. Ferrocement biogas plant

Note: Singular DEWATS units are also provided where the process is created as a precast concrete assembly with various chambers. These are provided by Centre for Scientific Research(CSR). Auroville and EXNORA, Chennai along with other partners.

Further Readings

DEWATS: Decentralised Wastewater Treatment in Developing Countries

By Ludwig Sasse, BORDA

<http://documents.scribd.com/docs/1ptpt0a12zsowos99331.pdf>

[C.eldoc1/d70d/undp1_980101zzz1B.pdf]

Decentralised Wastewater Treatment Systems, SANDEC,

[C.eldoc1/d70d/undp1_021126zzz2B.pdf]

Decentralised Wastewater Treatment Systems Dissemination Project, Indonesia,

[C.eldoc1/d70d/undp1_080228zzz1B.pdf]

Design Principles for Decentralized Wastewater Treatment Systems.

FEDINA BORDA.

<http://www.gtz.de/ecosan/download/Bangalore03-Kraemer.PDF>

[C.eldoc1/sanitation/dewats-ppt.PDF]

The coming of age of DEWATS - Decentralised Wastewater Treatment Systems

by Be!Sharp

[C.eldoc1/d70d/undp1_040101zzz1B.pdf]

FBBR - FLUIDIZED BIOLOGICAL BED REACTOR

The FBBR- (Fluidized Biological Bed Reactor) is one of the other **DECENTRALISED WASTE TREATMENT SYSTEMS** approved by the government in tsunami affected areas

Design Concept

Waste water is treated through the aerobic process in FBBR-1 and FBBR-2. Sludge is first dried in the drying bed and then used as a fertilizer. Pathogens are removed with the help of chlorination.

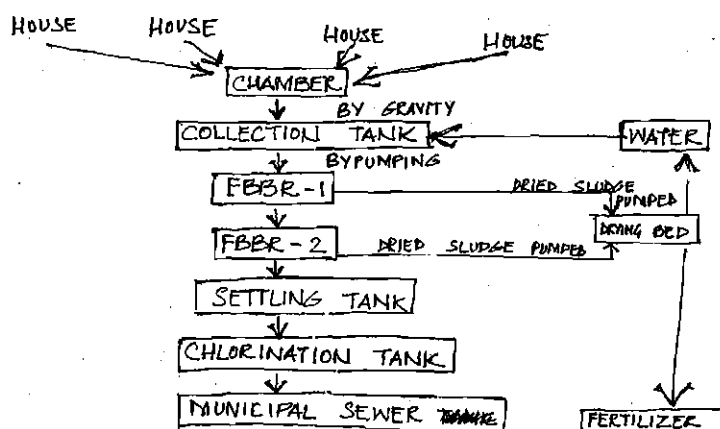

Traditionally Fluidized bed filter consists of a bed of granular media maintained in a constant state of expansion or fluidization. The media consists of particles with water negative buoyancy like sand, plastic beads, glass beads, crushed shells.

The biofilm in the fluidized bed reactors is evenly distributed throughout the reactor. In fluidized bed, each particle becomes coated with biofilm that grows as organics and other nutrients are extracted from the passing water. The microorganisms of the biofilm degrade the pollutants,

This technology, designed by NEERI [National Environmental Engineering Research Institute] Nagpur is feasible in settlements with more than 200 houses. This system is highly energy intensive, requires highly skilled workers for construction as well as for operation and maintenance. It needs uninterrupted power supply. This technology has been implemented in places like- Apollo Hospital, Hyderabad and Mumbai Airport.

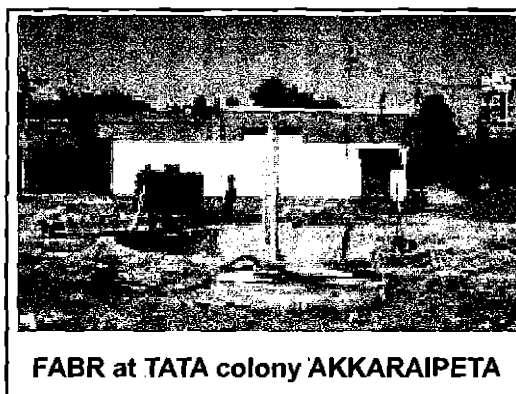

FABR at TATA colony AKKARAIPEETA

Further Reading

Consultation on Habitat Planning and Development: Post Tsunami-shelter reconstruction perspective in Tamil Nadu.

http://www.un.org.in/untrs/reports/Shelter_Habitat_2007_Consultation_report_draft.pdf

[C.eldoc1/0707/TS1_Shelter_Habitat_2007_Consultation_report_draft.pdf]

Sewage Treatment Methods by TWAD Board [R.D70d.626]

IV

Other Technical Details

Most elements of construction are known to our local masons. In fact they are more familiar with local conditions and with local construction methods. The only thing to be kept in mind is that the lining for the pits, and chambers must be according to the type of latrine. And soil conditions and water table level decide many elements of the structure. Otherwise, the slab is common to all construction, and the chimney has to be higher than the roof.

The main elements of the toilet structure are

Roof

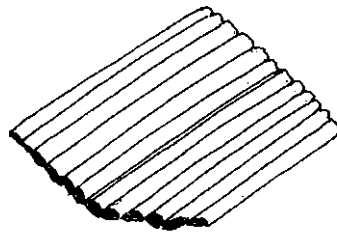

Superstructure & vent

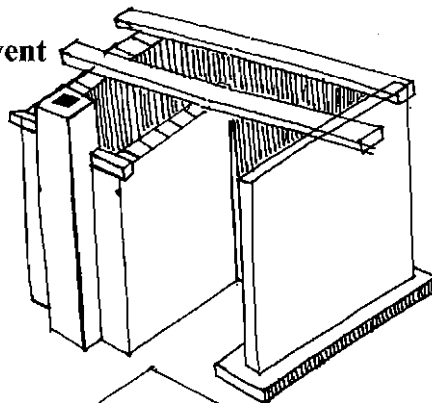

Toilet Floor Slab

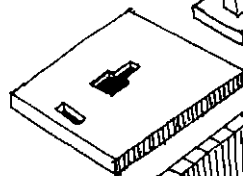

Chamber

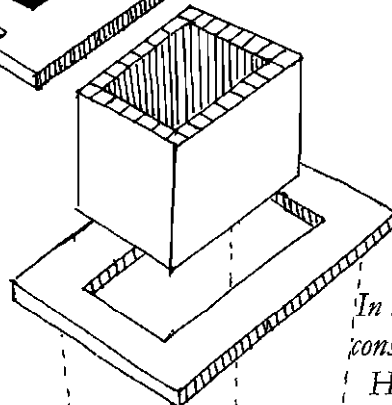

Foundation of wall

Pit lining & base.

In this section we look at the elements of construction particular to toilets taken from How to construct a brick VIP latrine, by Nicholas Greena.re. African Med.w.a. & Research Foundation [C.eldoc1/d70d/how-to-construct-VIP-latrine.pdf]

SPISF - Single Pass Intermittent Sand Filter

Design Concept

From the Toilet chamber, the waste is collected in a Sump and pumped into a Septic Tank, where the solid waste is separate from the black and gray water.

The Black and gray water is filtered by pumping under low pressure (to ensure even distribution), through a vertical graded gravel filter. The typical sand filter is a concrete or PVC-lined box filled with a specific sand material. A network of small-diameter pipes is placed in a gravel-filled bed on top of the sand. The water is circulated about 6 or 7 times by pumping. The media grains of the sand filter provide a large surface area for many different organisms to live on, which results in a stable process.

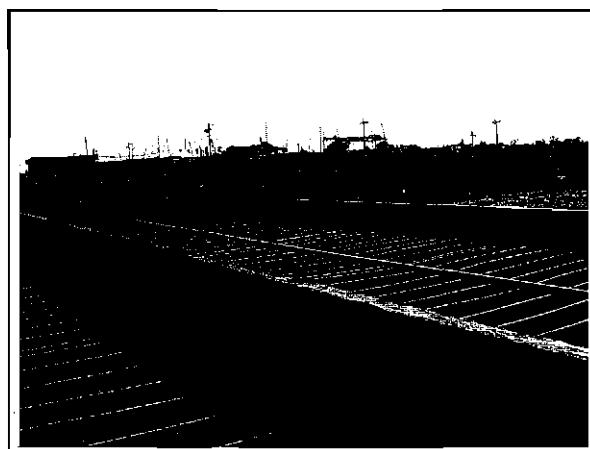
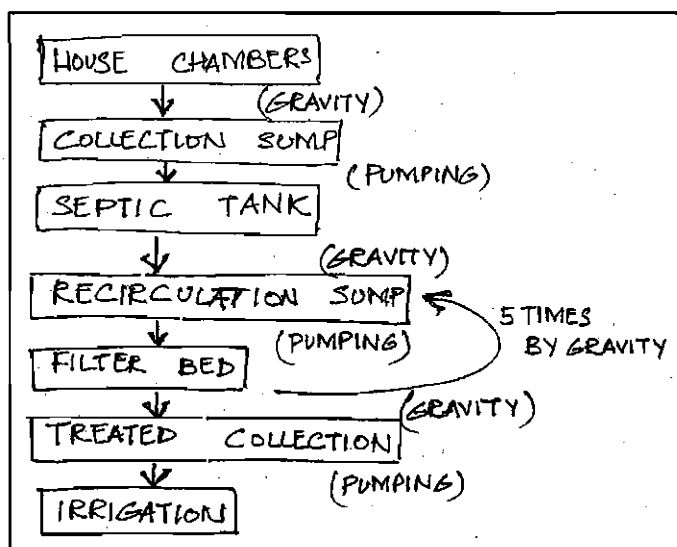

The effluent leaves the pump, trickles downward through the gravel, and is treated as it filters through the sand. A gravel under-drain collects and moves the treated wastewater to discharge (pumped or gravity). The accumulation of solids must be removed periodically.

The technology designer by TWAD board [TAMILNADU WATER SUPPLY AND DRAINAGE BOARD] Chennai requires high energy, skilled labour and has high recurrent costs.

SPISF has been implemented in Samanthanpettai, Nagapattinam [Case Study in CED film 'What Song Shall I Sing Today?'] and in Devanampattinam in Cuddalore

Further reading:

Sewage Treatment Methods by TWAD Board [R.D70d.626]

Single Pass Sand Filter Component Manual For Private Onsite Wastewater Treatment Systems, State Of Wisconsin Department Of Commerce Division Of Safety And Buildings, June 25, 1999
<http://Commerce.Wi.Gov/Sbdocs/Sb-Powtsmanualsinglepass.Pdf>
 [C.eldoc1/d70d/undp1_990625zzz4B.pdf]

CONSTRUCTION OF PITS

Construction notes

The distance between the diagonally opposite corners in the figure below should be 143 cms, with an error margin of not more than 1-2cms.

Excavation

Mark a circle in the ground using 2 sticks and a string. For a family latrine, the circle should be 1.5 meters (5 feet) across, so the string should be 75 cms long between the two sticks. For a school or community latrine, the diameter should be 1.8 meters across, so the string should mark a radius of 90-cm (3 feet)

Layout- 3:4:5 method

Put Peg A, Tie a string to it. Put another Peg B 2 meters away from this Peg. Put the third Peg C about 30 cms from the Peg B toward A. Take the string from Peg B to the outside of Peg C and mark the point where the string crosses the AB line, keeping the string straight. Mark another point 30 cms from this mark. Measure 40 cms from the first mark along the CD line and mark a third point. The distance between the second and the third marks should be 50 cms exactly. Place a Peg D about 1.5 meters from Peg C. Take the string from around the outside of the peg. Put Peg E about 30 cms from Peg D. Take the string around the outside of Peg E. The string must cross the line from C to D at 75 cms mark. Measure 75 cms again from Peg A and put Peg F on line with Peg A. Put in Peg G and Peg H making sure that both the long sides are 1.2 meters from the CD line. Measure the diagonals. They should both be 143 cms with a leeway of 1-2 cms

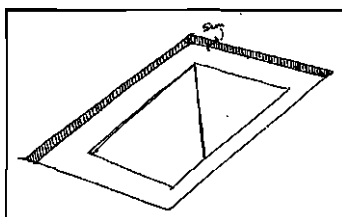
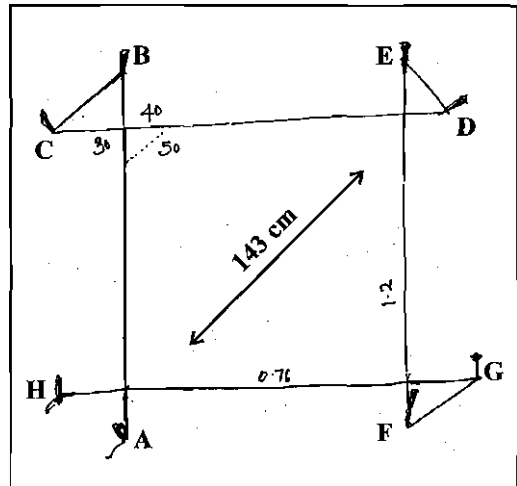

LINING- Areas with unstable ground

Lining is a must in such areas to avoid the pit from collapsing. In areas where the ground is very stable only ring beams are required.

For Hard Ground

1. Dig to full depth, mark out 20 cms all around
2. Dig soil out 5cms deep all around
3. Put concrete on ledge & impact it well until it is level with ground
4. Leave it overnight to set well.

For Soft Ground

1. Mark out an extra of 30 cms all around the pit
2. Dig the soil out until the ground is firm
3. Remove loose soil and level the ground

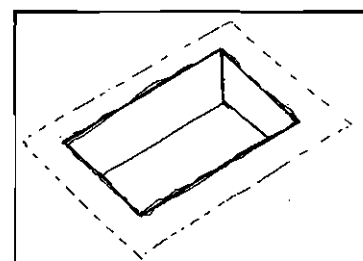

Lining

1. Mix 1 part cement, 3 parts sand and 6 parts aggregate
2. Pour this concrete on the ledge to form a foundation 5 cms thick
3. Put two 8mm steel bars as reinforcement in weak places
4. Leave overnight to set

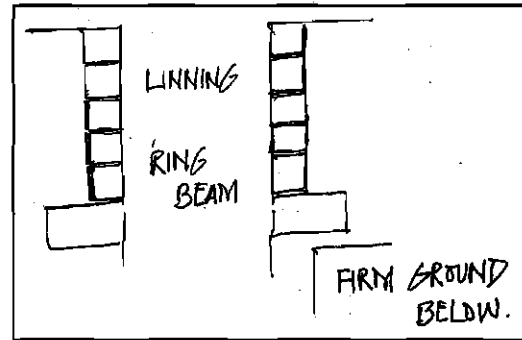

How to build Lining

- Pour water over concrete
- Place a layer of mortar [6 parts sand, 1 part cement] at the corners and lay the corner bricks 5 cms from the edge
- After placing the first line of bricks measure the diagonals. They should be 155 cms each.
- Continue building until the lining is 10 cms above the ground level.

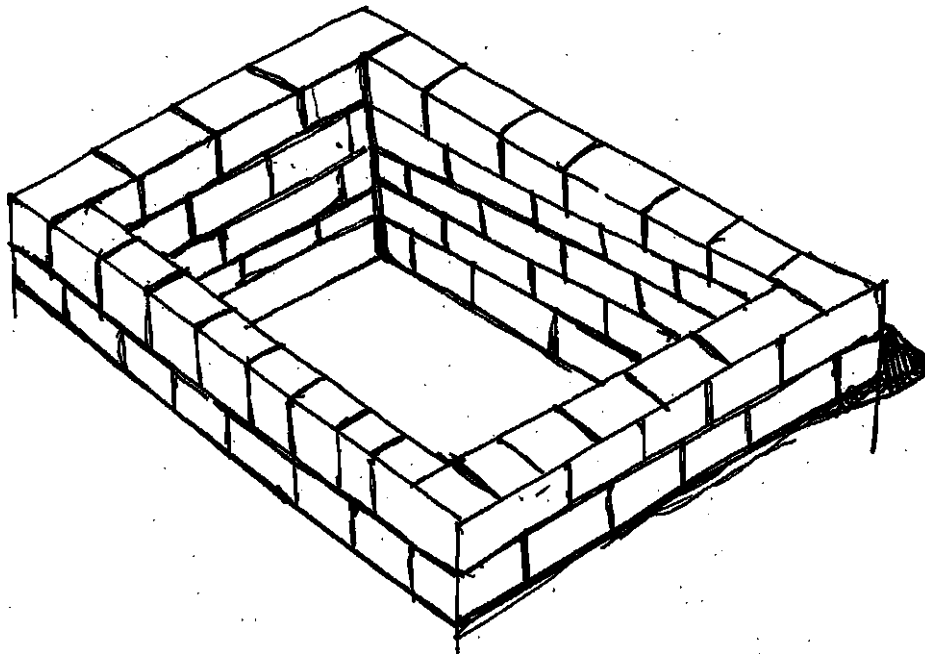

CONSTRUCTION OF FLOOR SLABS

Making Moulds

There are two ways to do floor slabs: Cutting the shape into the ground method or by making a timber frame. For cutting the shape into the ground, use a spirit level to cut the dimensions: 5cms deep, 150 cms long and 105 cms in width.

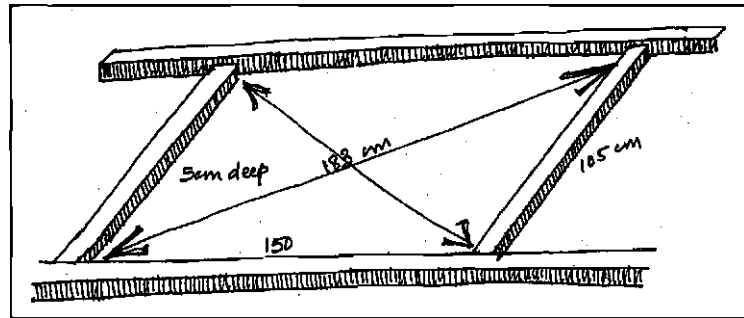

While making the timber frame check that the diagonals are equal to 183 cm and make sure all corners make 90 degrees angles.

Squat hole mould

Make the mould for the squat hole as under

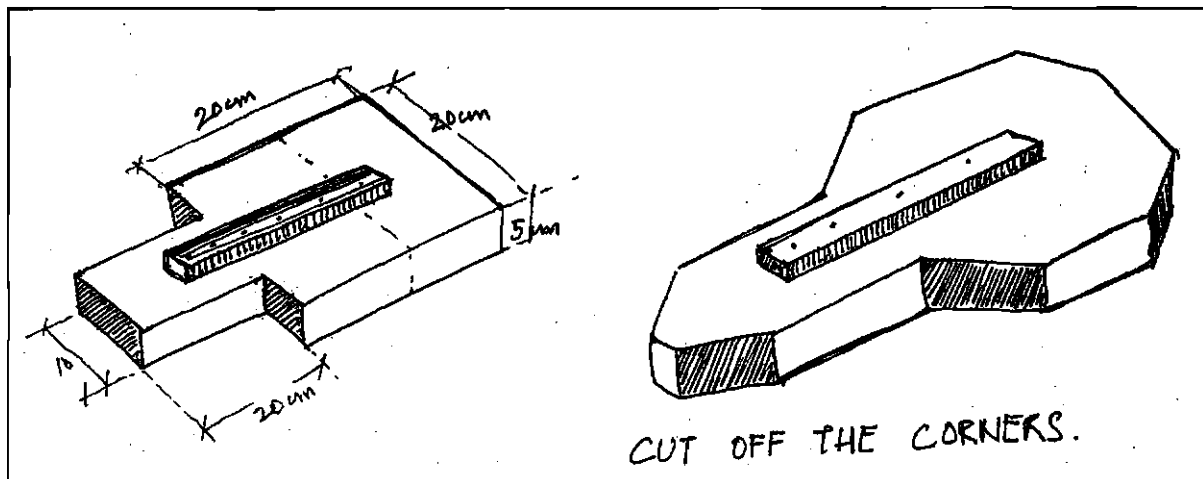

Vent pipe mould

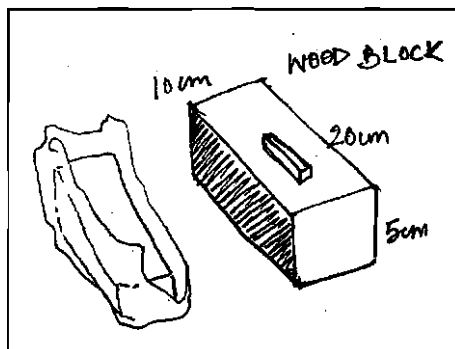

Either a brick wrapped in paper or a wood block

Reinforcement

- Clear a flat even area for the slab.
- Spread plastic sheets on the ground
- Cut a piece of mesh (BRC.610) to the size of the mould
- Place the vent mould one brick width from end
- Place the squat hole mould one the width of one brick + 20 cms in front of the vent mould
- Cut the mesh away from under the moulds.

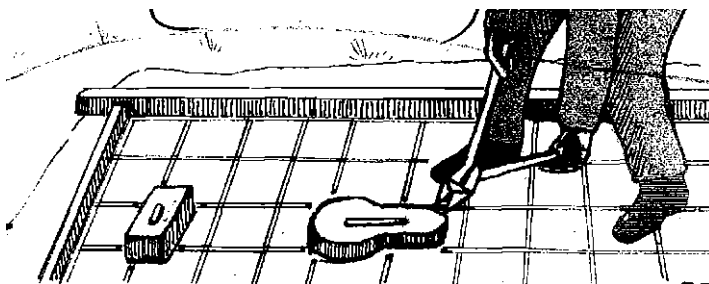

Concrete mix

Concrete Mix: 1 part cement, 2 parts sand, 4 parts aggregate

- Prepare a dry mixture. Add water
- Put little concrete into the frame
- Raise BRC 610 so it is in the centre of the concrete
- Compact the concrete to make it level with the top of the frame
- Finish with a wooden float

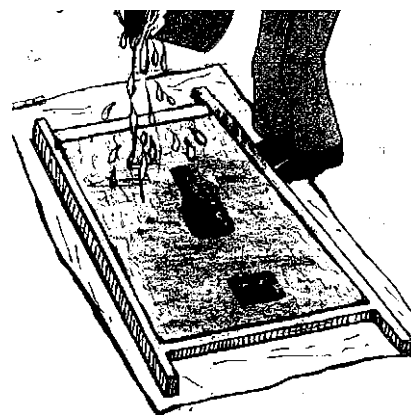

! Do not make the concrete slab too wet as this will make it weak and cracks will develop

Curing the Concrete

After 30 mins remove the squat hole mould and vent pipe mould.

Every day for a week pour water on the concrete and cover it with plastic, grass or sand to keep it damp.

Placing the Floor Slab

Put a mortar layer on the top course of the bricks.

Fill the earth around lining.

Lift the slab onto the lining and make sure it is level.

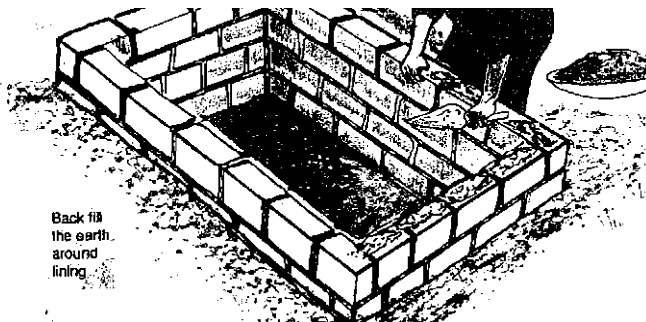

VENT PIPE AND FLY SCREEN

How to control odour and flies?

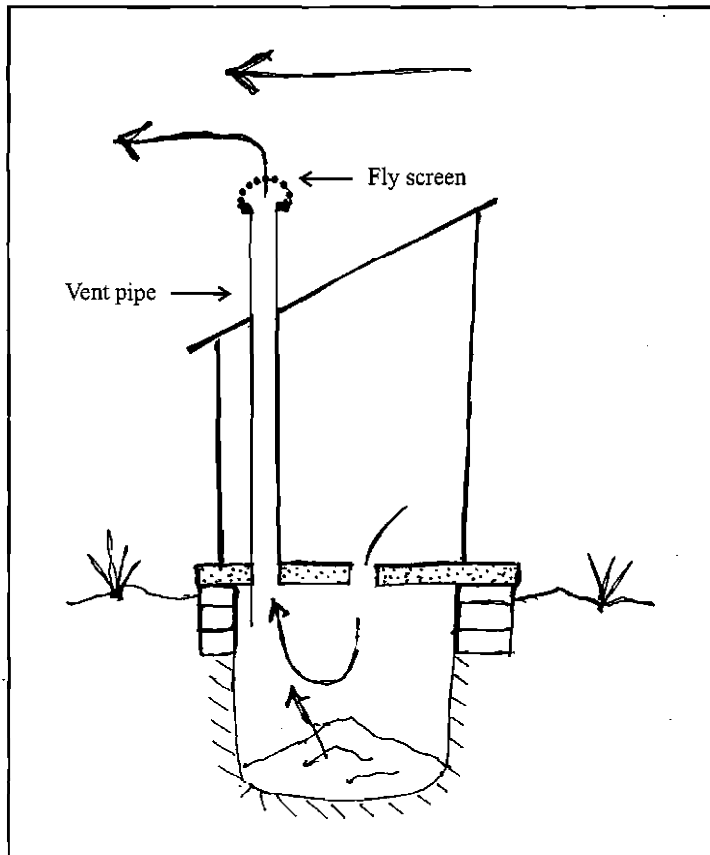

A screened ventilation pipe reduces odour and flies. The vent pipe draws out air from the pit or vault, mostly by the action of air passing across the top of the pipe. One option for the vent pipe material is to use 110mm PVC. The air that flows out of the pipe is replaced by air passing down the squat hole or pedestal. This is most efficient when the slab and pit collar are sealed and airtight and the head of the pipe is not surrounded by trees.

Any foul odour from the pit or vault does not escape into the superstructure, but is diluted by air and passes out of the pipe into the atmosphere. The vent also helps to remove moist air from the pit or vault which helps to reduce the moisture content of the excreta. Regular addition of

soil, wood ash and leaves to the pit can also help to reduce odour.

Flies can be eliminated by using a screen fitted vent pipe. Corrosion resistant aluminum or stainless steel screens must be used. The toilet house must be kept in semi-darkness and a roof is essential. Where the interior of the toilet is kept semi-dark, flies will enter the pipe from the pit or vault attracted towards the light and become trapped by the screen.

Cut a piece of wire mesh 30 cm X 30 cm to fit the top of the vent pipe. Using cement plaster it on to the top of the vent pipe,

The vent pipe must be 35 cms higher than the roof.

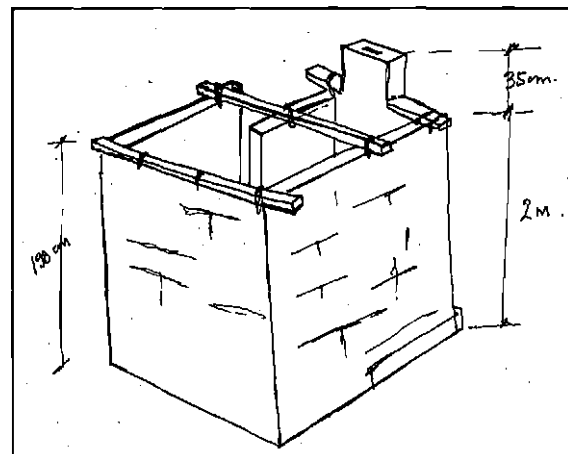

SCHOOL TOILET DESIGNS

While designing school/ anganwadi toilets following factors should be considered:

- Width of the toilet pans.
- Height of urinals.
- Height of hand-washing facilities (taps, soap, etc. are reachable).
- Distance between the footrests of squatting platforms.
- Height of door handles.

Children of different ages have also different physical strength and motor skills, requiring special solutions. Following aspects must also be considered and measured:

- Height of doorknobs and locks.
- Height of steps and handrails of stairs.
- Weight of the doors.
- Strength needed to open taps, fetch water, etc.
- Diameter of the squatting hole (needs oftentimes also psychological considerations because of fear of falling through)
- Please refer anthropometric data on next page

Taken from School and anganawdi toilet designs-Technical Note Series, Government of India, 2004. [C.eldoc1/d70d/Sch-Toilet-Design-govt.pdf]

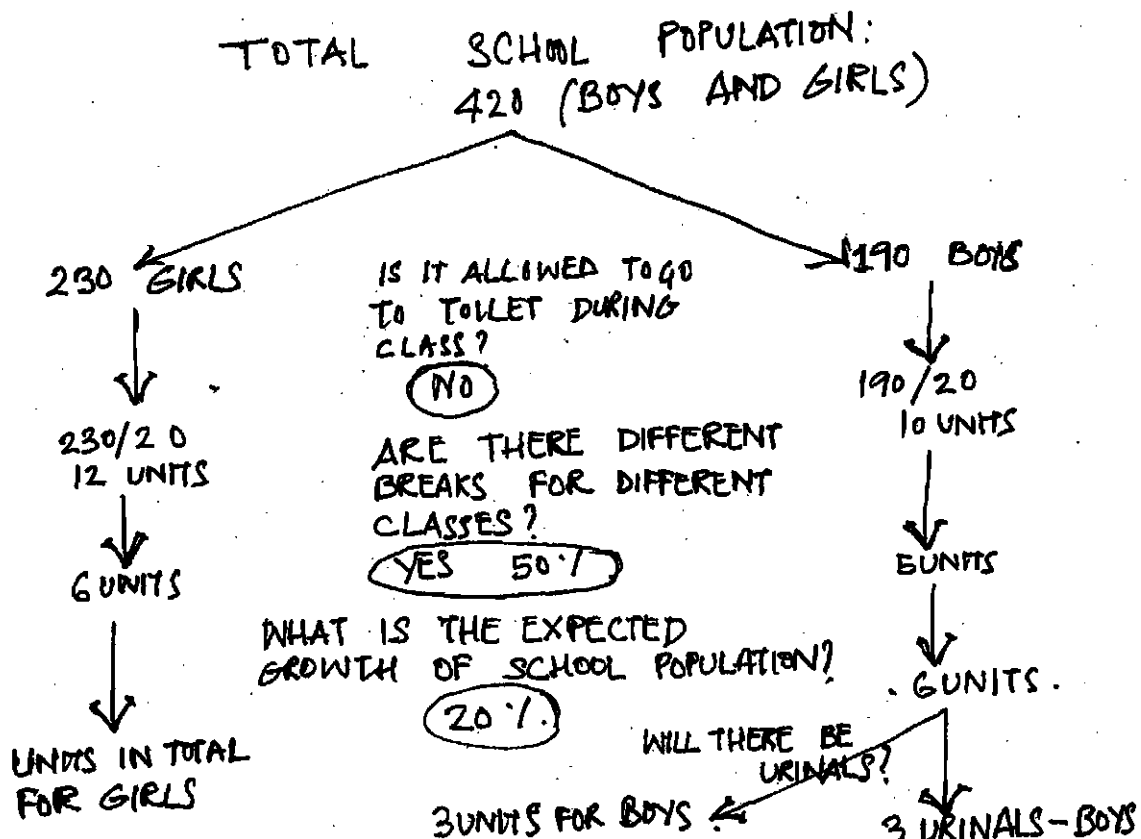

ANTHROPOMETRIC DATA FOR CHILDREN (Both Sexes)

Source : Architectural Graphic Standards

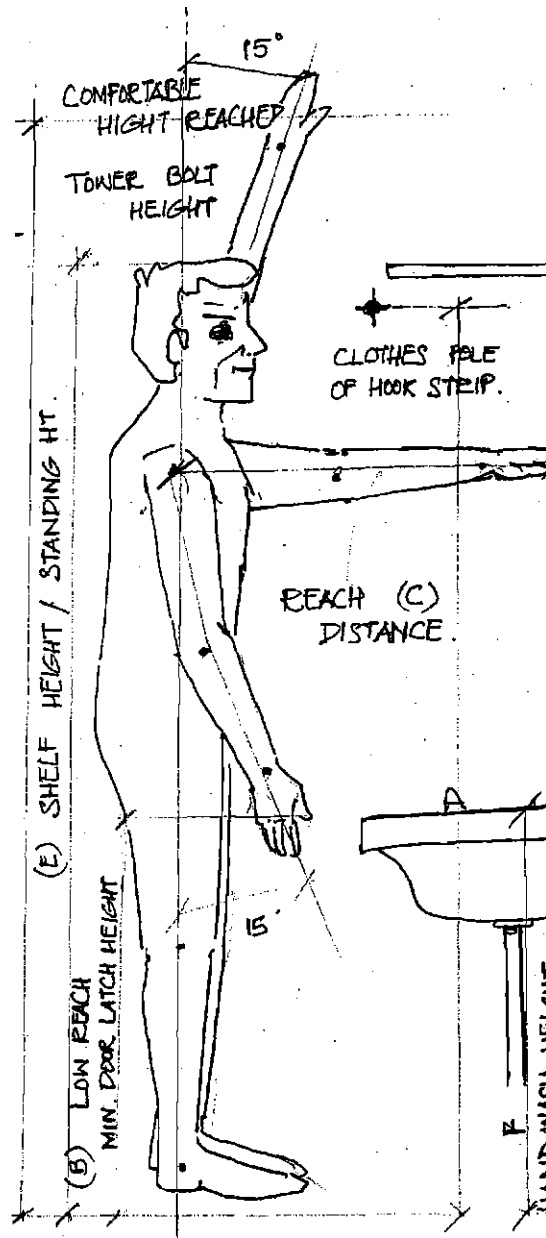

Ages	Tower Bolt Height		Door Latch Height		Reach Distance		Hook Strip or Clothes Pole		Shelf/ Standing Height		Hand Wash Height	
	mm	in.	mm	in.	mm	in.	mm	in.	mm	in.	mm	in.
15	1915	75.5	730	28.5	685	27.0	1575	62.0	1675	66.0	760	30.0
12	1705	67.0	630	24.5	620	24.5	1365	54.5	1485	58.5	685	27.0
9	1510	59.5	555	22.0	550	21.5	1220	48.0	1320	52.0	635	25.0
7	1370	54.0	510	20.0	495	19.5	1120	44.0	1220	48.0	585	23.0
5	1210	47.5	465	18.5	435	17.0	990	39.0	1090	43.0	485	19.0

Note: all above dimensions are for an Average Height Student

Anthropometric Data for Children-friendly Toilet Design

HANDWASH

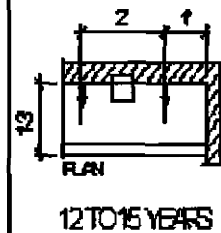
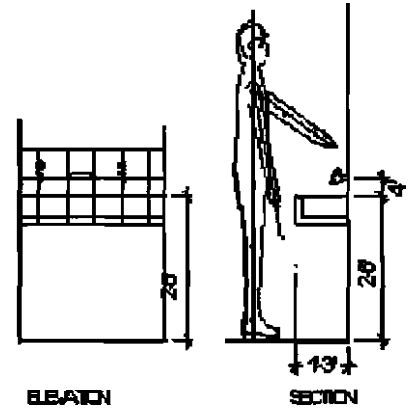
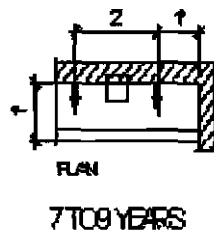
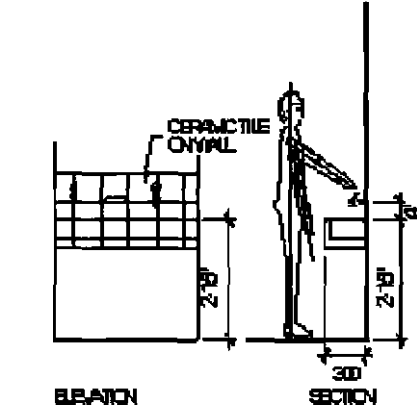
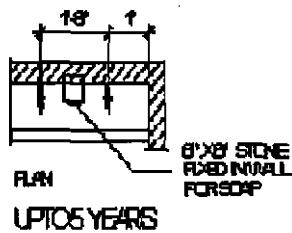
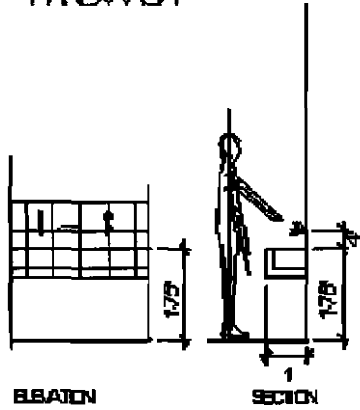

URINALS

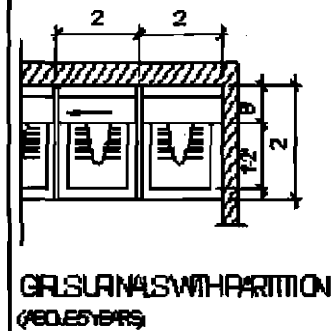
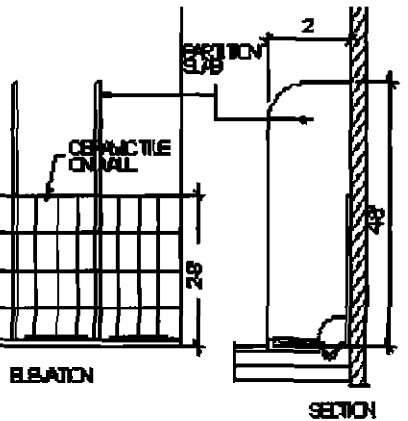
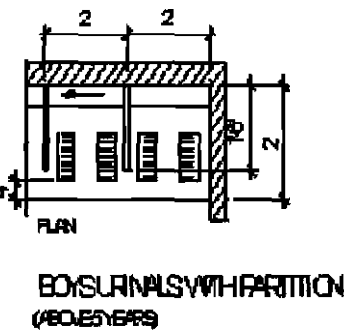
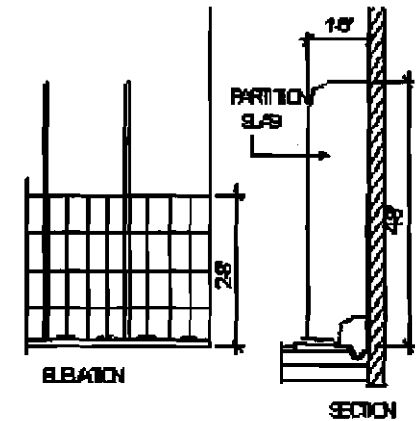
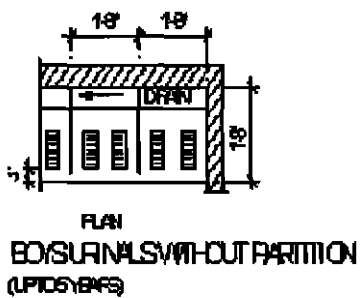
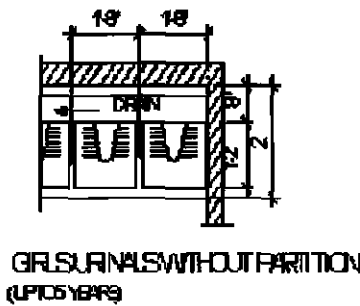

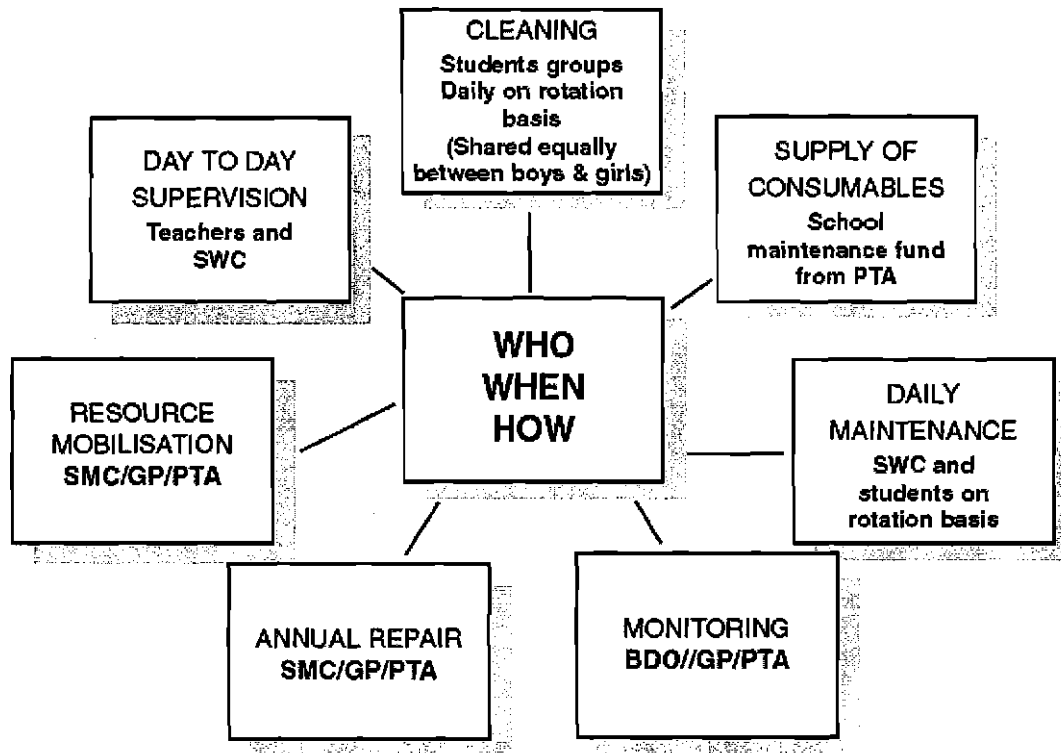

Further Readings

For more details and various design options and norms refer to

School and anganawadi toilet designs and norms -Technical Note Series, Department of Drinking Water Supply, Ministry of Rural Development, Government of India, January 2004

[[C.eldoc1/d70d/Sch-Toilet-Design-govt.pdf](http://ddws.nic.in/Sch-Toilet-Design-govt.pdf)]

[Http://ddws.nic.in/SchToiletDesign.pdf](http://ddws.nic.in/SchToiletDesign.pdf)

Technical Note Series-School and aganwadi toilet designs. Department of Drinking Water Supply, Ministry, of Rural Development, Govt of India.
[C.eldoc1/d70d/Sch-Toilet-Design-govt.pdf]

School Sanitation Systems, Gramalaya. [C.eldoc1/d70d/community-san-sys-school.doc]

School Sanitation and Hygiene Education in India: Investment in Building Children's Future, Department of Drinking Water supply.
[C.eldoc1/d70d/SSHE-in-India-Paper-2004.pdf]

LOW COST INCINERATOR

Under the Total Sanitation Campaign a low cost technology Incinerator has been installed in several schools and women's sanitary complex to dispose the toilet waste like soiled cloth, toilet paper; particularly sanitary napkins and cloth used during periods. The waste is converted to ash using the incinerator.

The incinerator consists of two chambers, an emission control system along with a door for firing and removal of ash. In each incinerator, there is an opening in the toilet wall for disposal of soiled napkins into the chamber. The soiled napkins drop on the wire gauze in the chamber. The waste thus dropped is fired on a weekly basis through the firing inlet in the lower chamber. The entire incinerator is attached to the outer wall of the building. A fan is connected to the top of the incinerator to eliminate the smoke and gases produced during the firing of waste.

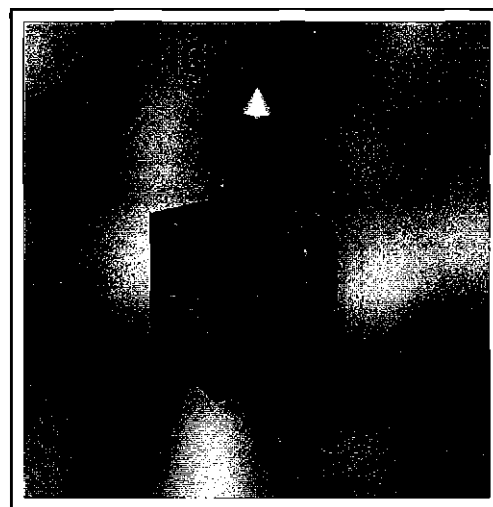

Cost breakup for incinerator

	Materials	Quantity	Rate	Amount
1	Country Bricks	250	1.25	313.00
2	Cement	2 bags	150/bag	300.00
3	Sand	-	150	150.00
4	Weld Wire Mesh	9 sqft	9.50	85.00
5	Cuddapah Slab	12 sqft	15.00	180.00
6	Labour Charges		200.00	200.00
7	AC Pipe 6 feet length, cover pipe, camp, nail		150.00	150.00
8	Whitewash, colour, washing, painting lettering and photo		122.00	122.00
	Total			1500.00



! IMPORTANT

The Rates may fluctuate in different areas.



For more details contact P Amudha, Project
Officer, UNICEF, Email: pamudha@unicef.org

Further Readings:

Incinerator for School Toilet Waste, Case Study: Tamil Nadu
[[C.eldoc1/d70d/case_study_tamilnadu.pdf](#)]
ddws.gov.in/sshe/html/case_study_tamilnadu.pdf

Taken from Simplified Sewerage, Sanitationconnection
[[C.eldoc!/d70d/undp1_020101zzz1B.html](#)]

Resources

Training and Educational Materials

For any programme to be successful there is need for a good training and IEC (information, education and communication) resources. This appendix gives you a brief idea of the videos, posters, and other AV materials that are available. Wherever possible we have given you the contact details. However in case you cannot access them directly, CED has kept a copy of these at its archives in Bangalore, and will be only too happy to send them to you on request. From time to time we will make additions and amendments.

Another important aspect of a successful programme is to be able to access the experts, and NGOs who are specialised to handle these programmes. We are therefore also providing you a list of such resources. The updated version is available at our website.

Needless to say that, we may have missed out important resources and persons. Kindly write to us at cedban@doccentre.net. You may also fill up these details directly on our website, and these will be displayed.

1. Training and IEC materials

Films

1. Changing Currents: Not A Dirty Word, Centre for Science And Environment, The Television Trust For The Environment, 26Mins/ English, 12/11/2005, [L.D70d.V932]
The film looks at the issue of access to safe water and basic sanitation, and its centrality to any kind of development process. Includes India's Sulabh International's acclaimed low-cost, self-financed sanitation facilities that have led to rehabilitation of scavengers and Orangi project in Pakistan's Karachi, which has used a grassroots movement to create a self-financed sanitation grid.

2. Shanti Century Not Out- CED/RDC, 33Mins/Tamil & English, June/2007, [L.D70d.VB23a, b/095]

A film on a striking example of community awareness efforts by Shanthi, which led to the construction of 250 Ecosan toilets in a tsunami affected village in South India. The film showcases how the construction of Ecosan toilets has changed the lives of many villagers and how it has also strengthened the process of Shanti's empowerment.
Available at CED

3. ECOSAN, SCOPE [L.D70d.VB09]

This 13 minutes segment on an ecosan project in one household in a village near Trichy can be used as an awareness-raising tool. The film is available as part of a larger film (Title: "The human excreta index", 2005)

4. DEWATS-Aravind Eye Hospital, Centre for Science and Research, Auroville and Catholic Relief Service and BORDA. [L.D70d.VB76]

5. Innovation in Sanitation, Centre for Science and Research, Auroville. October 2004 [L.D70d.VB76]

Innovative use of Ferrocement for sanitation for Tsunami Affected Communities.

6. What Song Shall I Sing Today? , CED, English/Tamil 31 Min.32 sec. 2007 [L.D70d.VA95 a,b]

It's nigh onto 3 years after the Tsunami. Yet some people continue to live in temporary settlements, in deplorable conditions, with no proper water supply and toilet facilities. What song shall I sing today? journeys through the process of rebuilding of lives in the various phases of emergency relief to temporary shelters, and then on to permanent houses. It highlights the plight of those in temporary shelters hoping to get permanent houses; and of those in permanent settlements, awaiting the arrival of basic amenities - especially the hurdles placed by mindless application of regulatory provisions of the CRZ and the many other practical problems faced, that still keep some in temporary shelters. The irony is that sanitation conditions in some permanent settlements are far worse than what obtains in the temporary shelters.

Available at CED

7. Lets Clean up this mess!, Centre for Education & Documentation, Tamil (32mins12sec) & English (31min 6sec). [L.D70d.VB54 a, b/V115]

This is what the women at the East Devadhanam in Trichy decided. And they succeeded. Simple methods, collective awareness, commitment and action brought about good sanitation. The women's self-helpgroups in this slum are operating the first ever community-based DEWATS system in Tamil Nadu. A "pay and use" toilet complex, the income is being used for maintenance and the treated water is being used for growing vegetables.

Available at CED

8. Small Steps... Big Leaps!!! (Marathi with English Subtitled)- Swayam Shikshan Prayog, India, [L.D70d.VB04]. www.sspingia.org

When communities and local governments share a vision and work towards creating self-reliant villages small steps can result in Big Leaps. The film is a step-by-step guide for development for the grassroots, practitioners' donors and organizations.

9. No more Roving

1. Deenabandhu (Hin) 2. Low Cost Sanitation (Hin) 3. Vidhyan Ashram (Hin) 4. Vikas Bharati(Hin) 5. Centre of Science for Villagers (Hin) 6. The Awakening -(Eng) 7. An Alternative -(Hin) 8. Capart Film ,Tribals, The Awakening -(Hin)
[V.zzz.755/LV.755 a+b+c]

10. Community Led Total Sanitation (CLTS) : Information & resources

Institute of Development Studies

The total elimination of open defecation holds promise of major gains in enhancing the wellbeing of women, children and men and in achieving the MDGs. Community-Led Total Sanitation (CLTS) is a participatory approach that started in Bangladesh and has been spread to varying degrees in India, Cambodia, Indonesia, China, Nepal. To a limited degree, it has also been trialled in some African countries. In a CLTS process, facilitators encourage communities to carry out their own appraisal and analysis of community sanitation. This generally leads them to recognise the volume of human waste they generate and how the practice of open defecation means they are likely to be ingesting one another's faeces. The resulting disgust and desire for self-respect can induce them to take immediate and comprehensive action by digging and building latrines and stopping open defecation without waiting for external support in the form of hardware subsidy.

Project Dates: 1 April 2006 – 31 October 2008

[L.D70d.S700]

11. Four Documentary film on Sanitation :

Chikhalwadi Setting Precedents:Duration:11.58

Inauguration at Shivaji Nagar: Duration :05:43

Pune toilets, Partnerships : Duration 9 :44

Sandas Mela New Rituals : Duration 13:14 by **SPARC**, Society For Promotion of Area resurce Centres [L.D70d.VB83]

12. Igniting Change :Towards total Sanitation in Maharashtra (English), Kabir Khan, Water and Sanitation Program-South Asia (24min,30sec) [L.D70d.VB84]

13. WASH : Water Sanitation Hygiene : For Development It's the big issue by Peter Adamson, [28 mins]. [L.D70d.S701]

The consequences – for human health and dignity, for the quality of life and for the environment – make this the most devastating of all the many problems associated with poverty. Yet whether it is because the issue is seen as unglamorous, or whether because it affects mainly the poorest of the poor, the ‘WASH’ issue (water, sanitation, hygiene) is the great neglected cause of our times. This publication can be read cover to cover in less than 5 minutes. It sets out some of the most important facts, issues, opinions, and lessons learned about water, sanitation, and hygiene in recent years.

14. Sulabh Sanitation Movement (With PDF file and Flash Player 6). Sulabh International Social Service Organisation. [L.D70d.S702]

In India, two noteworthy examples of public-private collaboration in the area of public services are the public call offices (PCOs), which revolutionized the availability of telephone services all over the country in the 1990s, and the Sulabh Sauchalayas, which are estimated to have provided sanitation facilities to ten million people at very low cost.

15. The Sulabh Sanitation Movement, Sulabh, 15min.38sec [L.D70d.VB85]

INTERVIEWS (*Available at CED*)

1. Toilets: Too many yet no relief - An interview with V Ganapathy , Special Correspondent, The Hindu [retd].

A lot has been written about the achievements of tsunami rehabilitation and reconstruction work. But what is the ground reality? V Ganapathy brings to the forefront the gruesome situation in the tsunami settlements, both temporary and permanent.

2. Ecological Sanitation...Eat, Excrete, Compost ! - An interview with M Subburaman, Director,SCOPE,Trichy

In the interview Subburaman tells about SCOPE’s experiment in building Ecosan toilets in the tsunami affected village Kameshwaram. Subburaman believes that Ecosan toilets will prove to be very useful particularly in the future when water will be a limited resource.

3. Shanthi...Now 250 not out! - An interview with Shanthi. Owner of the 1st Ecosan in Kameshwaram and Village Vice President.

Shanthi, an ordinary SHG member (in Kameshwaram) has more than 200 Ecosan toilets to her credit. Today Kameshwaram has the highest number of Ecosan toilets in the entire Nagapattinam district and thanks to Shanthi many more Ecosan toilets are going to be constructed.

4. Sanitation for all: Choices and Options, An interview with Vijay Anand,
[Exnora International]

Vijay Anand talks about different types of toilets and waste water treatment systems available and what factors need to be taken into consideration before selecting any one type.

POSTERS

1. Open Defecation – Lack of Privacy
2. Community's role towards sanitation
3. Shanthi's Century- 100 Ecosan toilet
4. Ecological Sanitation- Closing the loop
5. Chain connection of diseases spreading from feces to mouth
6. How to use toilets(give thumbnail and link to full size tif file for download)
7. Good sanitation practices(give thumbnail and link to full size tif file for download)

1. சூழல் மேம்பாட்டு சுகாதாரம், ஸ்கோப், திருச்சி,
[C.eldoc1/d70d/Sughal_Mannpadu_Sugadharam.pdf]
2. மூன்னெற்றம் - ஏப்ரல் - மே 2007 மாத இதழ், கிராமாலாயா, திருச்சி
[C.eldoc1/d70d/Munnattram.pdf]
3. திடக்கழிவு மேலாண்மை, ஸ்கோப், திருச்சி,
[C.eldoc1/d70d/Kuppaikalai_Sirandha_Muraiyal_Kaiyalvadhai.pdf]
4. கைகளை முறையாக கழுவிடுவோம், வாட்டர்எய்ட்டு, இந்தியா,
[C.eldoc1/d70_/Kaikali_Muraiyakka_Kaghviduvoam.pdf]
5. சுகாதாரம் - செயல்களும், வழிமுறைகளும் நம்மிடமே, வாட்டர்எய்ட்டு, இந்தியா,
[C.eldoc1/d70_/Sugadharam_Sayalkalazhyum.pdf]
6. வளர் இளம் பெண்களுக்கான இரத்த சோகை தடுப்புத் திட்டம், Uncief
[C.eldoc1/d41_/Valar_Illam_Pengalkana_Ratha.pdf]
7. எருக்குழி கழிவரை, Bless,
[C.eldoc1/d70d/Erukuzhi_Kazivarai.pdf]
8. சுகாதாரக் கழிப்பரை, Uncief,
[C.eldoc1/d70d/Sugadara_Kaziparai.pdf]
9. நல்ல உடல் நலத்திற்கு அடிப்படை சுகாதாரம், Uncief
[C.eldoc1/d70d/Nalla_Udal_Nalathirkka.pdf]
10. வயிற்றுப் போக்கு ,Uncief,
[C.eldoc1/d70_/Vaitru_Pooku_Noithaddop.pdf]

Information Resources & Reference

As mentioned earlier, the references in this docswb, have not been included for academic purposes, but to acknowledge the sources of information, as well as give you access to the literature that will help social workers and activists in the field. Their selection does not so much indicate attribution of original ideas and research, as they do accessibility. You may access the material directly from the website indicated. Since some of these links tend to get outdated, a back-up copy can be accessed from our documentation.

Please send us any additional information that you may have by email: cedban@doccentre.net.

Reading Material in Tamil

- சுழல் மேம்பாட்டு சுகாதாரம், எம் சுபுராமன், ஸ்கோப், திருச்சி (D70d.619)
- சுகாதார ஜோதி, முழு ஊரக சுகாதார இயக்கம், கடலூர், (R.D70d.620)
- சுகாதார வாழ்க்கை, யூனிசெகப், சென்னை, (R.D70d.618)
- குழந்தைகளுக்கான சுகாதார பாடல்கள், எஸ்.தாமோதரன், கிராமாலயா திருச்சி, (R.D70d.616)
- நீர்த்தொட்டி கழிப்பரையின் தோல்விக்கான சுற்றுச்சூழலடிப்படையிலான தீர்வுகள், பால் கால்வெர்ட், எகோ செல்யூஷன், யு.கெ. (R.D70d.615)
- சுகாதாரம் நம் கையில், கிராமாலயா திருச்சி (R.D70d.617)
- அயொடின் பற்றாக்குறையைக் களைதல் : பள்ளிக் குழந்தைகளின் பங்கு (R.D70.609)
- ஒருங்கிணைந்த குழந்தை வளர்ச்சித் திட்டத்தின் அறிமுகப் பயிற்சி (R.D43.633)
- உலக சுகாதார நிறுவனம், ஐக்கிய நாடுகள் குழந்தைகள் நல நிறுவனம் மற்றும் சுகாதாரம் மற்றும் குடும்ப நல அமைச்சகம் இணைந்து வழங்கும் (R.D70.610)
- Children Hygiene drawing book (Z04.601)
- சுகாதார ஜோதி

1. Issues on Sanitation

India Water Supply and Sanitation: . India Country Team, Energy and Infrastructure Department, South Asia Region, World Bank. January 2006.

a) Bridging the Gap Between Infrastructure and Service, Background Paper on Rural Water Supply and Sanitation.

http://siteresources.worldbank.org/INDIAEXTN/Resources/Reports-Publications/366387-1140691677823/WorldBank_BG_RuralReport.pdf

b) Bridging the Gap Between Infrastructure and Service, Background Paper on Urban Water Supply and Sanitation:

http://siteresources.worldbank.org/INDIAEXTN/Resources/Reports-Publications/366387-1140691677823/WorldBank_BG_Urban_20Feb06.pdf

Scaling-Up Rural Sanitation in South Asia : Lessons Learned from Bangladesh, India, and Pakistan by Catherine Revels. [C.eldoc1/d70d/01may05wsp1.pdf]

Guidelines for Implementing WATSAN components in Flood Affected Areas.
http://www.wesnetindia.org/fileadmin/attachments/Press_Releases/Guidelines.pdf.
[C.eldoc1/d70d/undp1_080315zzz5B.pdf]

Sanitation Now: A Magazine on the Global sanitation Crisis. Stockholm Environment Institute.
<http://www.ecosanres.org/sanitationnow2008.htm> .
[C.eldoc1/d70d/undp1_080101zzz1B.pdf]

Sanitation for all - Still a long way to go : Learnings & Approaches, WaterAid India.
http://www.wateraid.org/documents/plugin_documents/sanitation_for_all__still_a_long_way_to_go.pdf. [C.eldoc1/d70d/undp1_060901zzz1B.pdf]

Microfinance for Water, Sanitation and Hygiene-An introduction.
<http://www.waterland.net/showdownload.cfm?objecttype=mark.hive.contentobjects.download.pdf&objectid=19CE8B1E-DE1E-B77E-09D6D4AC29CCADE9>.
[C.eldoc1/d70d/undp1_071001zzz3B.pdf]

2. Types of Sanitation Units

Do-it-yourself- Recycle and Reuse Wastewater, Centre for Science and Environment, 2008. [G73.B61]

The Field Directors' Handbook - An OXFAM Manual for Dev. Workers, Brian Pratt & Jo Boyden, Oxford University Press [B.Q40.P2]

3. Technical Details

Designs and Use of Toilets.
http://www.whoindia.org/LinkFiles/Publications_Water_Sanitation_Chapter12.pdf.
[C.eldoc1/d70d/undp1_080317zzz2B.pdf].

Smart Sanitation Solutions, IRC/Peter McIntyre. Netherlands Water Partnership, WASTE, PRACTICA, IRC and SIMAVI,
http://www.irc.nl/content/download/24282/273405/file/SSS_2006.pdf.
[C.eldoc1/d70d/undp1_060101zzz2B.pdf]

Guidelines Central Rural Sanitation Programme Total Sanitation Campaign December 2007, Department of Drinking Water Supply Ministry of Rural Development Publication: Government of India,
<http://ddws.gov.in/popups/TSC%20Guideline%20Oct07.pdf>.
[C.eldoc1/d70d/undp1_071201zzz1B.pdf]

School and Anganawdi toilet designs-Technical Note Series. January 2004.
[C.eldoc1/d70d/Sch-Toilet-Design-govt.pdf]

Sanitation for a Healthy Nation-Technology Options.
http://www.dwaf.gov.za/dir_ws/content/lids/PDF/Technical.pdf.
[C.eldoc1/d70d/undp1_020201zzz1B.pdf]

Decentralized Waste Water Management Systems (DEWAMS) a Power-Point Presentation by, R.Pannirselvam, () 01/06/2007. [C: eldoc1/d70d/DEWAMS_New.html]

Design Principles for Decentralised Wasterwater Treatment Systems, a Power-Point Presentation by FEDINA-BORDA.

<http://www.gtz.de/ecosan/download/Bangalore03-Kraemer.PDF> [C.eldoc1.d70d/dewats-ppt.pdf]

Dry Compost Toilets in Tuticorin District, Kancheepuran and Cuddalore District

Urban Ecosan - the Dry Compost Toilet, Eco Tourism and Ecosan

3-way diversion Dry Compost Toilets, Dry Compost Toilets for Coastal and Riparian Communities

Sanitation in High Water Table Areas

Dry Compost Toilets for Water-Scarce Areas Support Agricultural Production and Home Gardens

The Dry Compost Toilet is a Winner Everywhere! Urban and Rural, Mountain and Plain, River and Coast!

Information Sheets by www.eco-solutions.org- http://eco-solutions.org/info_sheets.htm

Ecological Solutions to Flush Toilet Failures by Paul Calvert. Eco-Solutions. [English & Tamil], D70d.615b]

OTHERS

Microfinance for hygiene and sanitation-Netherland water partnership and IRC-international water and sanitation centre.

www.waterland.net/showdownload.cfm?objecttype=mark.hive.contentobjects.download.pdf&objectid=19CE8B1E. [C.eldoc1/d70d/undp1_071001zzz3B.pdf]

Micro-credit for Sanitation a Quiet Revolution, Tamil Nadu, India, September 2005. UNICEF- a WATSAN initiative. [C.eldoc1/d70d/Microcredit_For_Sanitation.pdf]

WatSan in Policy and Practice-Women's Role as Educators in Hygiene and Sanitation Education, A report by Nisha, Care India. [D70d.612]

Workshop Report for Capacity Building cum Exposure visit on Decentralised Waste Water Treatment System & Ecological Sanitation, April 2007. TNTRC, EXNORA International and SCOPE. [D70d.613]

Report on Suggestions for sustainable sanitation in Tsunami hit regions in South India by Dr A R Panesar, CARITAS Germany, February 2006. [D70d.614]

Practical Strategies for involving women as well as men in water and sanitation activities, Report prepared by Gender Office, Swedish International Development Office, SIDA Bureau by Sally Baden , May 1993. [D70d.604]

Learning from Experience-Water and Environment Sanitation in India; UNICEF. http://www.unicef.org/publications/files/pub_wes_en.pdf [C.eldoc1/d70d/Water-environment-sanitation.pdf]

Waste or Resource?, A backgrounder on Sanitation post-Tsunami, CED, 2007. [R.D70d.622]

For details of the government programmes, government orders and details about Panchayats in your area visit: <http://www.tn.gov.in/dtp/default.htm> Commissionerate of Town Panchayats, Tamil Nadu.

Contacts

Below is a selected list of resources persons and organisations, who have been working in the field of sanitation.

ORGANISATIONS

Center for Scientific Research (CRS) Auroville, Pondicherry, has been implementing and developing DEWATS for the last 20 years. The community operates at present more than 50 decentralizes treatment systems of different capacities and designs. The CRS in partnership with Auroville, AquaDyn, Auroville Water Harvest had pioneered a FRP model for DEWATS which in addition to ensuring a safe disposal of waste water, avoiding contamination of the ground water, could be shifted and reused from temporary to permanent shelters, thus optimizing the use of resources.

Contact: Tency Baetens, Executive, Auroshilpam, Auroville, Tamil Nadu, 605101

Swayam Shikshan Prayog seeks to build and enhance the core social, economic and political competencies of grassroots women's collectives and communities and drive them from the margin to the centre of development processes. One of its aims is to promote community led water and environmental sanitation.

Contact: Swayam Shikshan Prayog, 5th Floor, Bhardawadi Hospital, Bhardawadi Road, Andheri West, Mumbai 400 058, India Tel: +91-22-22907586, 26771132 Fax: +91-22-26771132. sspindia@vsnl.net www.sspindia.org

Society for Community Organisation and Peoples Education (SCOPE) for Ecological Sanitation, ECOSAN toilets.

Contact: M Subburaman, Director, P/17, 6th Cross, Ahmed Colony, Ramalinga Nagar, Woraiyur, Tiruchy – 620 003, Phone : 0431 – 2774144, Mobile : 94431 67190
E-mail : scopeagency86@rediffmail.com, scopeagency86@sify.com Website : www.scopetrichy.com www.scopeagency86@rediffmail.com

FEDINA, BORDA partner for DEWATS.

Contact: Dr. Duarte Barreto (Executive Trustee). Post Box 7101, # 154, Anjaneya Temple Street, Domlur Village, Bangalore 560 071. Phone: + 91 – 80 - 53 53 190, Fax: + 91- 80 - 53 53 563. E-mail: fedina@iqara.net

Consortium for DEWATS Dissemination (CDD) Society.

Contact: Joe D'Souza, , 220, 4thA Cross, 3rd Block, H R B R Layout, Kalyan Nagar, Bangalore 560 043. Email: cddindia@eth.net. www.borda-sa.org

Exnora International:

Contact: Vijay Anand, #20, Giriappa Road, T Nagar, Chennai 600017. Phone 91 44 2815 3376 / 91 44 2815 3377 / 91 44 2475 9477. Tele Fax 91 44 4219 3595. E-mail exnora@gmail.com. http://www.exnorainternational.org/other_divisions.shtml

BLESS- A Ruralisation Movement. Also a contact point for Soozhal, Network's rural sanitation initiative in the Cuddalore District of Tamil Nadu. A model for achieving total sanitation in low-income rural areas

Contact: L S Anthony Samy, Executive Director . BLESS, Salakkari, Cuddalore post, Cuddalore - 607 003. Tamil Nadu Phone : +91 04142 – 227254 91 (0) 94432 35730 admin@bless.org.in. www.blessngo.org.

GRAMALAYA.

Contact: J Geetha, Executive Director, No.12, 4th Cross West , Thillainagar ,
Tiruchirappalli - 620 018, Tamil Nadu , India Telephone: 91-431-2761263 Fax: 91-431-
2761263 , Email: gramalaya@hotmail.com

The Wave federation, facilitated by Gramalaya, has developed a polypropylene plastic sanitary pan, weighing 500 grams and costing Rs 60.



Centre for Appropriate Technology provides technical guidance and to implement national programmes on biogas development and construction of cost-effective buildings.
Contact: Augustine Xavier, Secretary , 5 Chithamparanathan Street, Vellalar Colony,
Ramavarmapuram Nagercoil, Tamil Nadu India 629001 91-4652-32927 (FAX: 91-4652-
32700)

Eco-solutions: Ecopans by Eco-solutions



Sustainable Technologies in the Community
49 Asan Nagar, Vallakkadavu,
Trivandrum- 695008, Kerala, India.
ecopans@eco-solutions.org
Call: 0471 2502622, 094477 62473

For Practical Hands-On Training; Ecosan Awareness and Orientation; Demonstration
Projects contact : Paul Calvert , 'Pulari', 49 Asan Nagar , Vallakkadavu , Trivandrum
695008 , Kerala, India. Tel : ++91 471 2502622, Mobile No. 094477 62473

Evangelical Fellowship of India Commission on Relief (EFICOR) Contact: Mr. David
Chandran, 48/72E, Chesney Town House, 105 Ethiraj Salai, Egmore, Chennai: 600008.
Phone :044-28221166/9444411395,65431877. chennai@eficor.org

AFPRO. For details of Deenabandhu 2000 Biogas plant. 25/1A, Institutional Area, D-Block, Pankha Road, Janakpuri, New Delhi – 110 058. Tel: +011 28525412, 28525452. Fax: 011 28520343. Email: afprodel@afpro.org, Web Site: www.afpro.org

List of contractors for installation of biogas plants

No	Name of the Company	Phone No. / Fax. No.
1	M/s NERD Society 78 A, Siddhi Vinayakar Colony, Vadavalli, Coimbatore 641 041	Tel : 0422 2422689 Fax : 0422 - 2425926
2	Thiru S. Velumani M/s Karumalaian Engineering Industry 1 / 379 1, KV Layout, Vidhya Nagar, Thindal (PO), Erode 638 009	Tel : 0424 239053, 239444
3	M/s Sundaram Fabricators Tiruchengode Main Road, 5 / 174, Andagalore Gate, Rasipuram Taluk, Salem 637 401	04287 - 231576
4	M/s Jayasree Industries Needamangalam Road, Kumbakonam 612 001	Tel : 0435 241 4687, 241 4135
5	Thiru V R Rajendran M/s Nirmal Biogen Agencies Chakku Pallam (PO), Kumili, Idukki Dt., Kerala 685 509	Tel : 04868 282866 Cell : 094470 50117
6	Thiru V Manoharan Bio Consultant 17, Ahimshapuram 1st Street (New extension) Ayyappan Street Sellur Madurai 625 002	Tel : 0452-2525067 Cell : 094431 86572

TAMIL NADU ENERGY DEVELOPMENT AGENCY
<http://www.teda.gov.in/page/Bio-Ann16.htm>

We will be updating this list periodically. Needless to say that, we may have missed out important resources and persons. Kindly write to us at cedban@doccentre.net.

Glossary

Activated Sludge - Biomass produced in raw or settled wastewater (primary effluent) by the growth of organisms in aeration tanks in the presence of dissolved oxygen.

Aerobic – living or taking place in the presence of air.

Aerosol -suspension of fine solid or liquid droplets in a gas

Alkaline treatment: the addition of wood ash or lime will reduce the number of pathogens due to the elevated pH. This treatment also reduces odour and the risk of attracting flies to the toilet.

Ammonia – is a compound with the formula NH_3 . It is normally encountered as a gas with a characteristic pungent odor. Ammonia contributes significantly to the nutritional needs of terrestrial organisms by serving as a precursor to foodstuffs and fertilizers.

Anaerobic – living or taking place in the absence of air or free oxygen.

Attached growth – Fixed microbial growth on the media surface in a filter bed.

Bacteria – single-celled microscopic organisms capable of causing diseases in humans, plants and animals. Certain bacteria are essential for wastewater treatment and pollution control because they break down organic matter present in the wastewater.

Biochemical Oxygen Demand (BOD) – the mass of oxygen consumed by organic matter during aerobic decomposition. It is always a fraction of COD. It describes what can be oxidised biologically, with the help of bacteria.

Biofilm - is a complex aggregation of microorganisms growing on a solid substrate.

Biomass - is a renewable energy resource derived from the carbonaceous waste of various human and natural activities. Biomass is a renewable energy source because we can always grow more trees and crops, and waste will always exist

Black water – wastewater containing excreta.

Chemical Oxygen Demand (COD) – the most general parameter to measure organic pollution. It describes how much oxygen is required to oxidise all organic and inorganic matter found in water.

Chlorination – is the process of adding the element chlorine to water as a method of water purification to make it fit for human consumption as drinking water. Water which has been treated with chlorine is effective in preventing the spread of disease.

Composting is the aerobic decomposition of biodegradable organic matter, producing compost. (Or in a simpler form: Composting is the decaying of food, mostly vegetables or manure.)

Cystitis - is an infection of the bladder, but the term is often used indiscriminately and covers a range of infections and irritations in the lower urinary system. It causes burning sensations during urination and a frequent need to urinate.

Desludging – removal of settled solids from pits, vaults and tanks.

Dehydration – process of extracting moisture resulting in dryness.

DEWAMS - Decentralized Wastewater Management System. In DEWAMS, pre-treatment is done to eliminate solids by putting in an interceptor tank like a septic tank where all settleable solids settle, and solids free effluent is let into the collection system.

Digested sludge – Decomposition of organic matter in sludge (the solids in wastewater) that results in partial liquefaction, mineralization and volume reduction.

Excreta – human faeces and urine.

Fluidisation - the operation by which the fine solids are transformed into a fluid-like state through contact with a gas or liquid.

Grey water – wastewater from bathing, laundry, preparation of food, cooking and other personal and domestic activities that does not contain excreta.

HCEST - Household Centered Environment Sanitation Toilet

Humus – decomposed organic matter.

Influent – water entering a particular process. Typically refers to the raw, untreated, wastewater entering a treatment facility.

Lpcd – Litres per capita per day.

Leptospirosis - is an infection in rodents and other wild and domesticated species. Rodents are implicated most often in human cases. The infection in human being is contracted through skin abrasions and the mucosa of the nose, mouth and eyes. Exposure through water contaminated by urine from infected animals is the most common route of infection.

Negative Buoyancy - exists when the weight of the body is greater than the weight of an equal volume of the displaced fluid and the body sinks.

Pathogen – disease-causing organism.

pH- An expression of the hydrogen ion concentration. A neutral solution will have a pH of 7, an acidic solution will have a pH of less than 7, and a basic solution will have a pH of greater than 7.

Primary treatment – part of the wastewater treatment process following pre-treatment. During primary treatment, some of the solid matter settles out of the wastewater.

Protozoa - are one-celled animals and the smallest of all animals.

PVC - Polyvinyl chloride

Schistosomiasis - Schistosomiasis also known as bilharzia (bill-HAR-zi-a), is a disease caused by parasitic worms. Freshwater becomes contaminated by Schistosoma eggs when infected people urinate or defecate in the water.

Secondary treatment – Is the stage in the wastewater treatment process, which follows primary treatment. Biological processes convert the remaining organic matter into a form, which is easier to remove from the wastewater.

Sedimentation Tank – A sedimentation tank or chamber is any container in which the velocity is slowed down to allow setting to occur.

Septic tank - A sewage-disposal tank in which a continuous flow of waste material is decomposed by anaerobic bacteria.

Sewage – the wastewater usually including excreta carried off by sewers or drains.

Sewerage – removal of surface water and waste matter by sewers. A system of sewers.

Sludge- The sinkable solids, which settle to the bottom of the tank, from the sludge layer. The Sludge is denser than water and fluid in nature, so it forms a flat layer along the tank bottom, Anaerobic bacteria consume organic matter in the wastewater, producing gases in the process and as they die, becoming a part of the sludge.

STP - Sewage treatment plants are used as the second step of cleaning placed beyond the adjusted cesspool or a septic tank.

Superstructure – screen or building of a latrine, above floor level, that provides privacy and protection for users.

Suspended matter- substances suspended in water, which can be removed by physical processes such as filtering.

Suspended Growth – the free-moving, aerobic, microbial culture used in the biological treatment of wastewater by the activated sludge process.

Virus – (from the Latin Virus - meaning "toxin" or "poison"), is a sub-microscopic infectious agent that is unable to grow or reproduce outside a host cell.

Water Seal – water held in U-shaped pipe or hemispherical bowl connecting a pan to a pipe channel or pit to prevent odour and flies.



United Nations Development Programme

Apex Towers, 54, 2nd Main Road, R.A.Puram, Chennai-600028, India
Tel: +91-44-4230 3551 Fax: +91-44-4230 3556 www.un.org.in/untr

UNDP is committed to help India achieve the global Millennium Development Goals (MDGs) as well as the nation objectives articulated in consecutive Five-Year Plans. The goal of the organization is to help improve the live of the poorest women and men, the marginalized and the disadvantaged in India. UNDP works in the following areas: Democratic Governance, Poverty Reduction, Disaster Risk Management, Energy and Environment, and HIV/AIDS.

In areas prone to disasters, UNDP furthers efforts to build the resilience of communities at risk and supports state and district institutions to prepare for and better manage disasters.



ARCHITECTURE & DEVELOPMENT

503, Kurupam Towers, East Point Colony, Visakhapatnam-530017, India
Tel: +91-891-2733845 www.archidev.org

Architecture & Development (A&D), registered as a trust in 2005, promotes and catalyzes sustainability in human habitats encompassing appropriate design, appropriate technologies, urban and rural development, and humanitarian and post-emergency situations. Its activities range from project planning to project implementation of a variety of projects, networking among NGOs, professionals and academia, information dissemination, initiating and implementing exchange programmes for professionals and development activists etc., with a special focus on marginalized sections of society.



Centre for Education & Documentation

3 Suleman Chambers, 4 Battery Street Be'hind Regal Cinema, Mumbai - 400 001, India
Tel: (022) 22020019 www.doccentre.net

CED is involved in documenting and disseminating primary and secondary information on over 700 issues of development. It has experience in coordinating production of various information materials: videos, press clipping,... It reaches out to a wide variety of audiences - students, journalists, NGOs, trade unions, civil society organisations, networks etc.

CED has two centres, in Mumbai and in Bangalore.

Disclaimer by Authors:

This manual does not seek to replace the many competent existing manuals nor does it purport to be the result of original work in the field of sanitation or habitat. It relies on work done by other NGOs, and organisations. Most text has been drawn from other open sources, public and NGO sources. These sources have been duly credited. The emphasis has been on education rather than on technical detail.